

Literature Review and Mathematical Modeling on Buckling of Laminated Composite Plates



Author

Osama Mohammed Elmardi Suleiman Khayal

Nile Valley University, Atbara – Sudan

November 2017

**Literature Review and Mathematical Modeling on
Buckling of Laminated Composite Plates**

Osama Mohammed Elmardi Suleiman Khayal

November 2017

Dedication

To the memory of my mother, father and aunt Zaafaran who taught me the greatest value of hard work and encouraged me in all my endeavors.

To my second mother Niemat Ibrahim Suleiman, hoping that she is in a good health.

To my beautiful three daughters Roa and her husband Khalid Amin , Rawan and Aya whose love is my shelter whenever it gets hard.

To my undergraduate and graduate students in Mechanical Engineering Department, Faculty of Engineering and Technology – Nile Valley University.

To Daniya Center Printing Services staff: Osama Mahmoud, Mohammed Mustafa, Manal Mohammed, Mustafa Abo Elgasim and Ahmed Abo Elgasim whose patience was the momentum that helped me in completing this book.

Acknowledgement

I am grateful and deeply indebted to Professor Mahmoud Yassin Osman for valuable opinions, consultation and constructive criticism, for without which this work would not have been accomplished.

I am also indebted to published texts in bending and buckling of composite laminated plates which have been contributed to the author's thinking. Members of Mechanical Engineering Department at Faculty of Engineering and Technology, Atbara – Sudan have served to sharpen and refine the treatment of my topics. The author is extremely grateful to them for constructive criticisms and valuable proposals.

I express my profound gratitude to Mr. Osama Mahmoud of Daniya Center for Computer and Printing Services, Atbara, who spent several hours in editing, re – editing and correcting the manuscript.

Contents

Dedication	I
Acknowledgement	II
Contents	III
List of Figures	V
List of Tables	VI
Preface	VII
CHAPTER (1) : Introduction	
1.1 General Introduction	1
1.2 Structure of Composites	3
1.2.1 Mechanical properties of a fiber-reinforced lamina	4
1.2.1.1 Stiffness and strength of a lamina	5
1.2.1.2 Analytical modeling of composite laminates	9
1.3 The Objectives of the Present Study	9
CHAPTER (2) : Literature Review	
2.1 Development in the Theories of Laminated Plates	11
2.2 Numerical Techniques Survey	16
2.3 The Past Work of Buckling Analysis	18
CHAPTER (3) : Mathematical Formulation and Numerical Modeling	
3.1 Introduction	27
3.2 Fundamental Equations of Elasticity	28
3.3 The Numerical Method	30
CHAPTER (4) : Conclusion	

Conclusion	41
BIBLIOGRAPHY	43
APPENDICES	
Appendix (A)	59
Appendix (B)	59
Appendix (C)	59

List of Figures

Serial	Description	Page
1.1	Structure of a fibrous composite.	4
1.2	Stress – strain relationships for fiber and matrix.	7
1.3	Variation of unidirectional lamina strength with the fiber volume fraction.	8
1.4	Unidirectional lamina loaded in the fiber direction.	8
2.1	Assumed deformation of the transverse normal in various displacement base plate theories.	14
3.1	The geometry of a laminated composite plate	28
3.2	A thin plate of length a , breadth b , and thickness h subjected to in – plane loads	29
3.3	Geometry of an n – layered laminate	29
3.4	External forces acting on an element	33
3.5	A four noded element with local and global co – ordinates	35

List of Tables

Serial	Description	Page
1.1	Properties of composite reinforcing fibers	2

Preface

This book was originally prepared in 2012 and updated recently in 2017. The objective of the present book is to present a complete and up – to – date coverage of composite laminates properties , literature reviews and mathematical modeling of laminated plates on buckling through the usage of a wide spectrum of old and recent bibliography.

The material presented in this book is intended to serve as an introduction , literature review and mathematical modeling of laminated plates on buckling of composite laminated plates. In chapter one, the introduction was presented from the points of view of fundamental definitions of fibrous composite laminates and micromechanical properties of fibers and matrix materials. At the end of the chapter the objectives of the present work were cited.

Chapter two contains a comprehensive literature review which includes continuous developments in the theories of laminated plates. Also, a survey of numerical techniques which could be used in the analysis of laminated plates.

In chapter three mathematical formulation and numerical modeling of laminated composite plates subjected to in – plane buckling load were derived and discussed thoroughly.

Chapter four contains the conclusion of the present book. In this chapter the important observations and findings were explained clearly.

The book is suitable as a review on theories of plates, mathematical modeling and numerical and / or analytical techniques subjected to bending, buckling and vibration of laminated plates.

Osama Mohammed Elmardi Suleiman Khayal
Mechanical Engineering Department,
Faculty of Engineering and Technology,
Nile Valley University, Atbara – Sudan
November 2017

CHAPTER (1)

Introduction

1.1 General Introduction:

Composites were first considered as structural materials a little more than three quarters of a century ago. From that time to now, they have received increasing attention in all aspects of material science, manufacturing technology, and theoretical analysis.

The term composite could mean almost anything if taken at face value, since all materials are composites of dissimilar subunits if examined at close enough details. But in modern materials engineering, the term usually refers to a matrix material that is reinforced with fibers. For instance, the term "FRP" which refers to Fiber Reinforced Plastic usually indicates a thermosetting polyester matrix containing glass fibers, and this particular composite has the lion's share of today commercial market.

Many composites used today are at the leading edge of materials technology, with performance and costs appropriate to ultra-demanding applications such as space crafts. But heterogeneous materials combining the best aspects of dissimilar constituents have been used by nature for millions of years. Ancient societies, imitating nature, used this approach as well: The book of Exodus speaks of using straw to reinforce mud in brick making, without which the bricks would have almost no strength. Here in Sudan, people from ancient times dated back to Meroe civilization, and up to now used *zibala* (i.e. animals' dung) mixed with mud as a strong building material.

As seen in table 1.1 below, which is cited by David Roylance [1], Stephen et al. [2] and Turvey et al. [3], the fibers used in modern composites have strengths and stiffnesses far above those of traditional structural materials. The high strengths of the glass fibers are due to processing that avoids the internal or external textures flaws which normally weaken glass, and the strength and stiffness of polymeric aramid

fiber is a consequence of the nearly perfect alignment of the molecular chains with the fiber axis.

Table 1.1 Properties of composite reinforcing fibers

Material	E (GN/m)	σ_b (GN/m)	ε_b (%)	ρ (Mg/m)	E / ρ (MN.m/kg)	σ_b / ρ (MN.m/kg)
E-glass	72.4	2.4	2.6	2.54	28.5	0.95
S-glass	85.5	4.5	2.0	2.49	34.3	1.8
Aramid	124	3.6	2.3	1.45	86	2.5
Boron	400	3.5	1.0	2.45	163	1.43
H S graphite	253	4.5	1.1	1.80	140	2.5
H M graphite	520	2.4	0.6	1.85	281	1.3

Where E is Young's modulus, σ_b is the breaking stress, ε_b is the breaking strain, and ρ is the mass density.

These materials are not generally usable as fibers alone, and typically they are impregnated by a matrix material that acts to transfer loads to the fibers, and also to protect the fibers from abrasion and environmental attack. The matrix dilutes the properties to some degree, but even so very high specific (weight – adjusted) properties are available from these materials. Polymers are much more commonly used, with unsaturated Styrene – hardened polyesters having the majority of low to medium performance applications and Epoxy or more sophisticated thermosets having the higher end of the market. Thermoplastic matrix composites are increasingly attractive materials, with processing difficulties being perhaps their principal limitation.

Recently, composite materials are increasingly used in many mechanical, civil, and aerospace engineering applications due to two desirable features: the first one is their high specific stiffness (stiffness per unit density) and high specific strength (strength per unit density), and the second is their properties that can be tailored through variation of the fiber orientation and stacking sequence which gives the designers a wide spectrum of flexibility. The incorporation of high strength, high modulus and low-density filaments in a low strength and a low modulus matrix material is known to result in a structural composite material with a high strength to weight ratio. Thus, the potential of a two-material composite for use in aerospace, under-water, and automotive structures has stimulated considerable research activities in the theoretical prediction of the behavior of these materials. One commonly used composite structure consists of many layers bonded one on top of another to form a high-strength laminated composite plate. Each lamina is fiber reinforced along a single direction, with adjacent layers usually having different filament orientations. For these reasons, composites are continuing to replace other materials used in structures such as conventional materials. In fact composites are the potential structural materials of the future as their cost continues to decrease due to the continuous improvements in production techniques and the expanding rate of sales.

1.2 Structure of Composites:

There are many situations in engineering where no single material will be suitable to meet a particular design requirement. However, two materials in combination may possess the desired properties and provide a feasible solution to the materials selection problem. A composite can be defined as a material that is composed of two or more distinct phases, usually a reinforced material supported in a compatible matrix, assembled in prescribed amounts to achieve specific physical and chemical properties.

In order to classify and characterize composite materials, distinction between the following two types is commonly accepted; see Vernon [4], Jan Stegmann and Erik Lund [5], and David Royslance [1].

1. Fibrous composite materials:

These materials are composed of high strength fibers embedded in a matrix. The functions of the matrix are to bond the fibers together to protect them from damage, and to transmit the load from one fiber to another. {See fig.1.1 }.

2. Particulate composite materials:

These materials are composed of particles encased within a tough matrix, e.g. powders or particles in a matrix like ceramics.

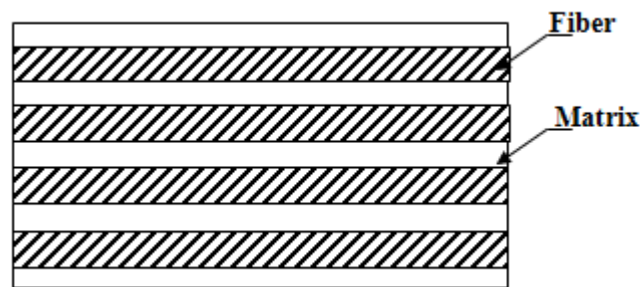

Fig. 1.1 Structure of a fibrous composite

In this book the focus will be on fiber reinforced composite materials, as they are the basic building element of a rectangular laminated plate structure. Typically, such a material consists of stacks of bonded-together layers (i.e. laminas or plies) made from fiber reinforced material. The layers will often be oriented in different directions to provide specific and directed strengths and stiffnesses of the laminate. Thus, the strengths and stiffnesses of the laminated fiber reinforced composite material can be tailored to the specific design requirements of the structural element being built.

1.2.1 Mechanical properties of a fiber reinforced lamina:

Composite materials have many mechanical characteristics, which are different from those of conventional engineering materials such as metals. More precisely, composite materials are often both inhomogeneous and non-isotropic. Therefore, and due to the inherent heterogeneous nature of composite materials, they can be studied from a micromechanical or a macro mechanical point of view. In

micromechanics, the behavior of the inhomogeneous lamina is defined in terms of the constituent materials; whereas in macro mechanics the material is presumed homogeneous and the effects of the constituent materials are detected only as averaged apparent macroscopic properties of the composite material. This approach is generally accepted when modeling gross response of composite structures. The micromechanics approach is more convenient for the analysis of the composite material because it studies the volumetric percentages of the constituent materials for the desired lamina stiffnesses and strengths, i.e. the aim of micromechanics is to determine the moduli of elasticity and strength of a lamina in terms of the moduli of elasticity, and volumetric percentage of the fibers and the matrix. To explain further, both the fibers and the matrix are assumed homogeneous, isotropic and linearly elastic.

1.2.1.1 Stiffness and strength of a lamina

The fibers may be oriented randomly within the material, but it is also possible to arrange for them to be oriented preferentially in the direction expected to have the highest stresses. Such a material is said to be anisotropic (i.e. different properties in different directions), and control of the anisotropy is an important means of optimizing the material for specific applications. At a microscopic level, the properties of these composites are determined by the orientation and distribution of the fibers, as well as by the properties of the fiber and matrix materials.

Consider a typical region of material of unit dimensions, containing a volume fraction, V_f of fibers all oriented in a single direction. The matrix volume fraction is then, $V_m = 1 - V_f$. This region can be idealized by gathering all the fibers together, leaving the matrix to occupy the remaining volume. If a stress σ_l is applied along the fiber direction, the fiber and matrix phases act in parallel to support the load. In these parallel connections the strains in each phase must be the same, so the strain ε_l in the fiber direction can be written as:

$$\varepsilon_l = \varepsilon_f = \varepsilon_m \quad (1.1)$$

(Where: the subscripts L, f and m denote the lamina, fibers and matrix respectively).

The forces in each phase must add to balance the total load on the material. Since the forces in each phase are the phase stresses times the area (here numerically equal to the volume fraction), we have

$$\sigma_l = \sigma_f V_f + \sigma_m V_m = E_f \varepsilon_l V_f + E_m \varepsilon_l V_m \quad (1.2)$$

The stiffness in the fiber direction is found by dividing the stress by the strain:

$$E_l = \frac{\sigma_l}{\varepsilon_l} = E_f V_f + E_m V_m \quad (1.3)$$

(Where: E is the longitudinal Young's modulus)

This relation is known as a rule of mixtures prediction of the overall modulus in terms of the moduli of the constituent phases and their volume fractions.

Rule of mixtures estimates for strength proceed along lines similar to those for stiffness. For instance consider a unidirectional reinforced composite that is strained up to the value at which the fiber begins to fracture. If the matrix is more ductile than the fibers, then the ultimate tensile strength of the lamina in equation (1.2) will be transformed to:

$$\sigma_l^u = \sigma_f^u V_f + \sigma_m^f (1 - V_f) \quad (1.4)$$

Where the superscript u denotes an ultimate value, and σ_m^f is the matrix stress when the fibers fracture as shown in fig.1.2.

It is clear that if the fiber volume fraction is very small, the behavior of the lamina is controlled by the matrix.

This can be expressed mathematically as follows:

$$\sigma_l^u = \sigma_m^u (1 - V_f) \quad (1.5)$$

If the lamina is assumed to be useful in practical applications, then there is a minimum fiber volume fraction that must be added to the matrix. This value is obtained by equating equations (1.4) and (1.5) i.e.

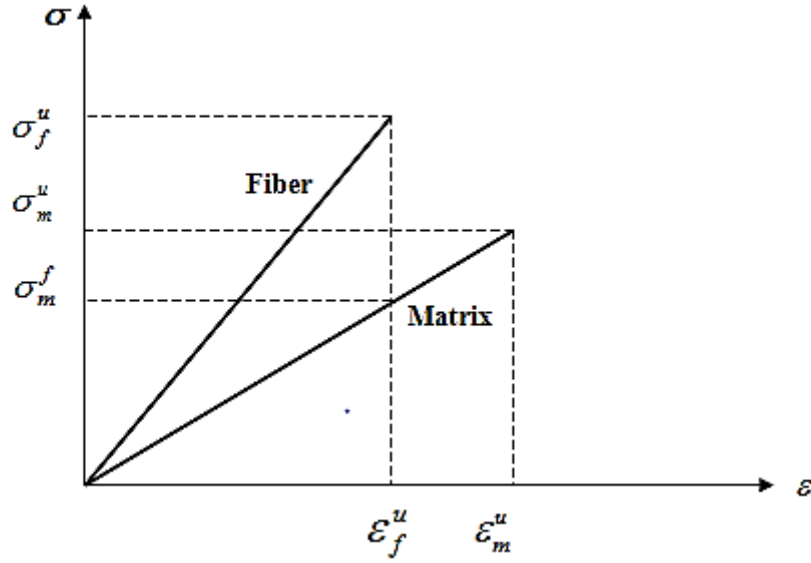

Fig .1.2 Stress-strain relationships for fiber and matrix

$$V_{min} = \frac{\sigma_m^u - \sigma_m^f}{\sigma_f^u + \sigma_m^u - \sigma_m^f} \quad 0 < V_f < V_{min} \quad (1.6)$$

The variation of the strength of the lamina with the fiber volume fraction is illustrated in fig. 1.3. It is obvious that when $0 < V_f < V_{min}$ the strength of the lamina is dominated by the matrix deformation which is less than the matrix strength. But when the fiber volume fraction exceeds a critical value (i.e. $V_f > V_{Critical}$), Then the lamina gains some strength due to the fiber reinforcement.

The micromechanical approach is not responsible for the many defects which may arise in fibers, matrix, or lamina due to their manufacturing. These defects, if they exist include misalignment of fibers, cracks in matrix, non-uniform distribution of the fibers in the matrix, voids in fibers and matrix, delaminated regions, and initial stresses in the lamina as a result of its manufacture and further treatment. The above mentioned defects tend to propagate as the lamina is loaded causing an accelerated rate of failure. The experimental and theoretical results in this case tend to differ. Hence, due to the limitations necessary in the idealization of the lamina components, the properties estimated on the basis of micromechanics should be proved experimentally. The proof includes a very simple physical test in which the lamina is

considered homogeneous and orthotropic. In this test, the ultimate strength and modulus of elasticity in a direction parallel to the fiber direction can be determined experimentally by loading the lamina longitudinally. When the test results are plotted, as in fig.1.4 below, the required properties may be evaluated as follows: -

$$E_1 = \sigma_1 / \varepsilon_1 ; \sigma^u = P^u / A ; \nu_{12} = -\varepsilon_2 / \varepsilon_1$$

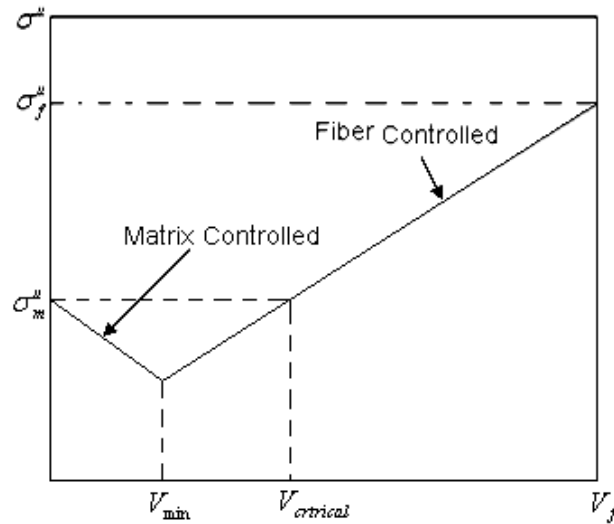

Fig. 1.3 Variation of unidirectional lamina strength with the fiber volume fraction

Similarly, the properties of the lamina in a direction perpendicular to the fiber direction can be evaluated in the same procedure.

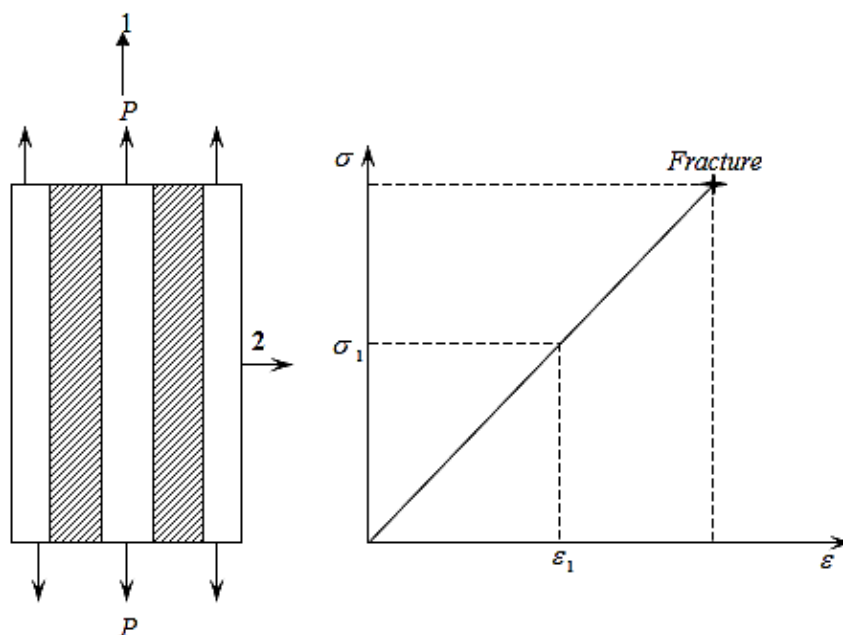

Fig.1.4 Unidirectional lamina loaded in the fiber-direction

1.2.1.2 Analytical modeling of composite laminates:

The properties of a composite laminate depend on the geometrical arrangement and the properties of its constituents. The exact analysis of such structure – property relationship is rather complex because of many variables involved. Therefore, a few simplifying assumptions regarding the structural details and the state of stress within the composite have been introduced.

It has been observed, that the concept of representative volume element and the selection of appropriate boundary conditions are very important in the discussion of micromechanics. The composite stress and strain are defined as the volume averages of the stress and strain fields, respectively, within the representative volume element. By finding relations between the composite stresses and the composite strains in terms of the constituent properties expressions for the composite moduli could be derived. In addition, it has been shown that, the results of advanced methods can be put in a form similar to the rule of mixtures equations.

Prediction of composite strengths is rather difficult because there are many unknown variables and also because failure critically depends on defects. However, the effects of constituents including fiber – matrix interface on composite strengths can be qualitatively explained. Certainly, failure modes can change depending on the material combinations. Thus, an analytical model developed for one material combination cannot be expected to work for a different one. Ideally a truly analytical model will be applicable to material combination. However, such an analytical model is not available at present. Therefore, it has been chosen to provide models each of which is applicable only to a known failure mode. Yet, they can explain many of the effects of the constituents. (Refer to Ref. [2]).

1.3 The Objectives of the Present Study:

The present work involves a comprehensive and thorough study of the following objectives:

1. Recognition of the fundamentals of composite laminates.

2. Study the mechanical properties of fibers and matrix materials of a lamina.
3. A survey of various plate theories and techniques used to predict the response of laminated plates under buckling and bending loads.
4. A survey of various analytical, semi – analytical and exact methods used in the analysis of laminated plates subjected to buckling and bending loads.
5. Study of the probable causes of composite materials delamination.

CHAPTER (2)

Literature Review

2.1 Developments in the Theories of Laminated Plates:

From the point of view of solid mechanics, the deformation of a plate subjected to transverse and / or in plane loading consists of two components: flexural deformation due to rotation of cross – sections, and shear deformation due to sliding of section or layers. The resulting deformation depends on two parameters: the thickness to length ratio and the ratio of elastic to shear moduli. When the thickness to length ratio is small, the plate is considered thin, and it deforms mainly by flexure or bending; whereas when the thickness to length and the modular ratios are both large, the plate deforms mainly through shear. Due to the high ratio of in – plane modulus to transverse shear modulus, the shear deformation effects are more pronounced in the composite laminates subjected to transverse and / or inplane loads than in the isotropic plates under similar loading conditions.

The three – dimensional theories of laminates, in which each layer is treated as homogeneous anisotropic medium, (see Reddy [6]) are intractable. Usually, the anisotropy in laminated composite structures causes complicated responses under different loading conditions by creating complex couplings between extensions and bending, and shears deformation modes. Except for certain cases, it is inconvenient to fully solve a problem in three dimensions due to the complexity, size of computation, and the production of unnecessary data specially for composite structures.

Many theories which account for the transverse shear and normal stresses are available in the literature (see, for example Mindlin [7]). These are too numerous to review here. Only some classical papers and those which constitute a background for the present thesis will be considered. These theories are classified according to Phan and Reddy [8] into two major classes on the basis of the assumed fields as: (1) stress based theories, and (2) displacement based theories. The stress – based theories are

derived from stress fields which are assumed to vary linearly over the thickness of the plate:

$$\sigma_i = \left(\frac{M_i}{h^2/6}\right) \times \left(\frac{z}{h/2}\right) \quad (i=1,2,6) \quad (2.1)$$

(Where M_i is the stress couples, h is the plate thickness, and z is the distance of the lamina from the plate mid – plane).

The displacement – based theories are derived from an assumed displacement field as:

$$\begin{aligned} u &= u_0 + z u_1 + z^2 u_2 + z^3 u_3 + \dots \\ v &= v_0 + z v_1 + z^2 v_2 + z^3 v_3 + \dots \\ w &= w_0 + z w_1 + z^2 w_2 + z^3 w_3 + \dots \end{aligned} \quad (2.2)$$

Where: u_0 , v_0 and w_0 are the displacements of the middle plane of the plate. The governing equations are derived using principle of minimum total potential energy. The theory used in the present work comes under the class of displacement – based theories. Extensions of these theories which include the linear terms in z in u and v and only the constant term in w , to account for higher – order variations and to laminated plates, can be found in the work of Yang, Norris and Stavsky [9] , Whitney and Pagano [10] and Phan and Reddy [8].

Based on different assumptions for displacement fields, different theories for plate analysis have been devised. These theories can be divided into three major categories, the individual layer theories (IL), the equivalent single layer (ESL) theories, and the three dimensional elasticity solution procedures. These categories are further divided into sub – theories by the introduction of different assumptions. For example the second category includes the classical laminated plate theory (CLPT), the first order and higher order shear deformation theories (FSDT and HSDT) as stated in Refs. { [11]–[14]}.

In the individual layer laminate theories, each layer is considered as a separate

plate. Since the displacement fields and equilibrium equations are written for each layer, adjacent layers must be matched at each interface by selecting appropriate interfacial conditions for displacements and stresses. In the ESL laminate theories, the stress or the displacement field is expressed as a linear combination of unknown functions and the coordinate along the thickness. If the in – plane displacements are expanded in terms of the thickness co – ordinate up to the n^{th} power, the theory is named n^{th} order shear deformation theory. The simplest ESL laminate theory is the classical laminated plate theory (CLPT). This theory is applicable to homogeneous thin plates (i.e. the length to thickness ratio $a / h > 20$). The classical laminated plate theory (CLPT), which is an extension of the classical plate theory (CPT) applied to laminated plates was the first theory formulated for the analysis of laminated plates by Reissner and Stavsky [15] in 1961 , in which the Kirchhoff and Love assumption that normal to the mid – surface before deformation remain straight and normal to the mid – surface after deformation is used (see fig.2.1) , but it is not adequate for the flexural analysis of moderately thick laminates. However, it gives reasonably accurate results for many engineering problems i.e. thin composite plates, as stated by Srinivas and Rao [16], Reissner and Stavsky [15]. This theory ignores the transverse shear stress components and models a laminate as an equivalent single layer. The classical laminated plate theory (CLPT) under – predicts deflections as proved by Turvey and Osman [17], [18], [19] and Reddy [6] due to the neglect of transverse shear strain. The errors in deflection are even higher for plates made of advanced filamentary composite materials like graphite – epoxy and boron – epoxy whose elastic modulus to shear modulus ratios are very large (i.e. of the order of 25 to 40 , instead of 2.6 for typical isotropic materials). However, these composites are susceptible to thickness effects because their effective transverse shear moduli are significantly smaller than the effective elastic modulus along the fiber direction. This effect has been confirmed by Pagano [20] who obtained analytical solutions of laminated plates in bending based on the three – dimensional theory of elasticity. He proved that classical laminated plate theory (CLPT) becomes of less accuracy as the side to thickness.

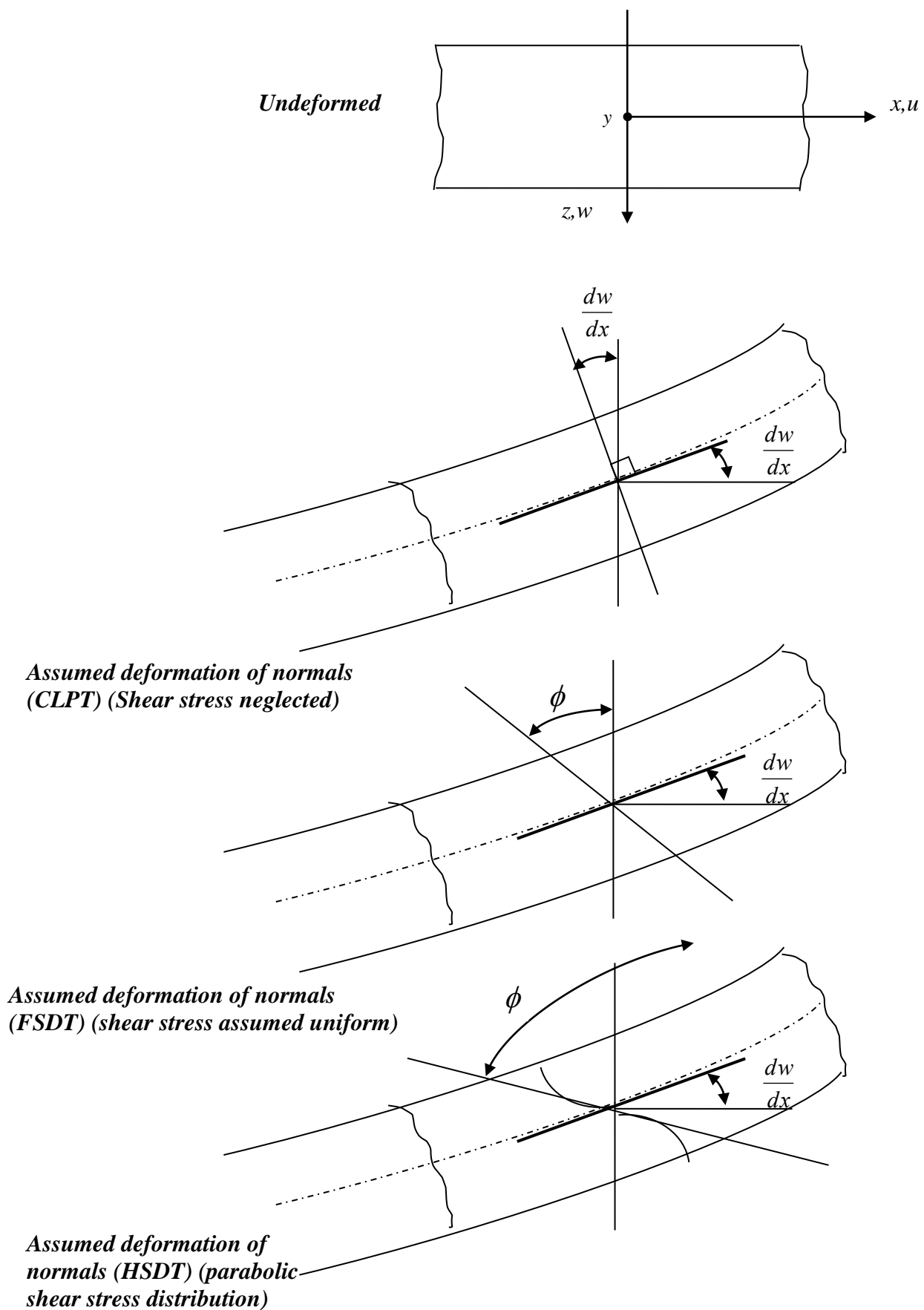

**Fig. 2.1 Assumed deformation of the transverse normal
In various displacement base plate theories.**

Ratio decreases. In particular, the deflection of a plate predicted by CLPT is considerably smaller than the analytical value for side to thickness ratio less than 10. These high ratios of elastic modulus to shear modulus render classical laminate theory as inadequate for the analysis of composite plates. In the first order shear deformation theory (FSDT), the transverse planes, which are originally normal and straight to the mid – plane of the plate, are assumed to remain straight but not necessarily normal after deformation, and consequently shear correction factors are employed in this theory to adjust the transverse shear stress, which is constant through thickness (see fig.2.1). Recently Reddy [6] and Phan and Reddy [8] presented refined plate theories that used the idea of expanding displacements in the powers of thickness coordinate. The main novelty of these works is to expand the in – plane displacements as cubic functions of the thickness coordinate, treat the transverse deflection as a function of the x and y coordinates, and eliminate the functions u_2 , u_3 , v_2 and v_3 from equation (2.2) by requiring that the transverse shear stress be zero on the bounding planes of the plate. Numerous studies involving the application of the first – order theory to bending, vibration and buckling analyses can be found in the works of Reddy [20], and Reddy and Chao [21].

In order to include the curvature of the normal after deformation, a number of theories known as higher – order shear deformation theories (HSDT) have been devised in which the displacements are assumed quadratic or cubic through the thickness of the plate. In this aspect, a variationally consistent higher – order theory which not only accounts for the shear deformation but also satisfies the zero transverse shear stress conditions on the top and bottom faces of the plate and does not require correction factors was suggested by Reddy [6]. Reddy's modifications consist of a more systematic derivation of displacement field and variationally consistent derivation of the equilibrium equations. The refined laminate plate theory predicts a parabolic distribution of the transverse shear stresses through the thickness, and requires no shear correction coefficients.

In the non – linear analysis of plates considering higher – order shear deformation theory (HSDT), shear deformation has received considerably less attention compared with linear analysis. This is due to the geometric non – linearity which arises from finite deformations of an elastic body and which causes more complications in the analysis of composite plates. Therefore, fiber – reinforced material properties and lamination geometry have to be taken into account. In the case of anti – symmetric and unsymmetrical laminates, the existence of coupling between stretching and bending complicates the problem further. Non – linear solutions of laminated plates using higher – order theories have been obtained through several techniques, i. e. perturbation method as in Ref.[22], finite element method as in Ref.[23], the increment of lateral displacement method as in Ref.[24],and the small parameter method as in Ref.[25].

2.2 Numerical Techniques:

Several numerical methods could be used in this study, but the main ones are finite difference method (FDM), dynamic relaxation coupled with finite difference method (DR), and finite element method (FEM).

In the finite difference method, the solution domain is divided into a grid of discrete points or nodes. The partial differential equation is then written for each node and its derivatives are replaced by finite divided differences. Although such point – wise approximation is conceptually easy to understand, it becomes difficult to apply for system with irregular geometry, unusual boundary conditions, and heterogeneous composition.

The DR method was first proposed in 1960th; see Rushton [26], Cassel and Hobbs [27], and Day [28]. In this method, the equations of equilibrium are converted to dynamic equations by adding damping and inertia terms. These are then expressed in finite difference form and the solution is obtained through iterations. The optimum damping coefficient and the time increment used to stabilize the solution depend on the stiffness matrix of the structure, the applied load, the boundary conditions and the size of mesh used.

In the present work, a numerical method known as finite element method (FEM) is used. It is a numerical procedure for obtaining solutions to many of the problems encountered in engineering analysis. It has two primary subdivisions. The first utilizes discrete elements to obtain the joint displacements and member forces of a structural framework. The second uses the continuum elements to obtain approximate solutions to heat transfer, fluid mechanics, and solid mechanics problem. The formulation using the discrete element is referred to as matrix analysis of structures and yields results identical with the classical analysis of structural frameworks. The second approach is the true finite element method. It yields approximate values of the desired parameters at specific points called nodes. A general finite element computers program, however, is capable of solving both types of problems and the name "finite element method" is often used to denote both the discrete element and the continuum element formulations.

The finite element method combines several mathematical concepts to produce a system of linear and non – linear equations. The number of equations is usually very large, anywhere from 20 to 20,000 or more and requires the computational power of the digital computer.

It is impossible to document the exact origin of the finite element method because the basic concepts have evolved over a period of 150 or more years. The method as we know it today is an outgrowth of several papers published in the 1950th that extended the matrix analysis of structures to continuum bodies. The space exploration of the 1960th provided money for basic research, which placed the method on a firm mathematical foundation and stimulated the development of multi – purpose computer programs that implemented the method. The design of airplanes, unmanned drones, missiles, space capsules, and the like, provided application areas.

The finite element method (FEM) is a powerful numerical method, which is used as a computational technique for the solution of differential equations that arise in various fields of engineering and applied sciences. The finite element method is based on the concept that one can replace any continuum by an assemblage of simply

shaped elements, called finite elements with well defined force, displacement, and material relationships. While one may not be able to derive a closed – form solution for the continuum, one can derive approximate solutions for the element assemblage that replaces it. The approximate solutions or approximation functions are often constructed using ideas from interpolation theory, and hence they are also called interpolation functions. For more details refer to Refs. {[29] – [31]}.

In a comparison between the finite element method (FEM) and dynamic relaxation method (DR), Aalami [32] found that the computer time required for the finite element method is eight times greater than for DR analysis, whereas the storage capacity for FEM is ten times or more than that for DR analysis. This fact is supported by Putcha and Reddy [23], and Turvey and Osman {[17] – [19]} who noted that some of the finite element formulations require large storage capacity and computer time. Hence due to the large computations involved in the present study, the finite element method (FEM) is considered more efficient than the DR method. In another comparison, Aalami [32] found that the difference in accuracy between one version of FEM and DR may reach a value of more than 15 % in favor of FEM. Therefore, the FEM can be considered of acceptable accuracy. The apparent limitation of the DR method is that it can only be applied to limited geometries, whereas the FEM can be applied to different intricate geometries and shapes.

2.3 The Past Work of Buckling Analysis:

Composite materials are widely used in a broad spectrum of modern engineering application fields ranging from traditional fields such as automobiles, robotics, day to day appliances, building industry etc. This is due to their excellent high strength to weight ratio, modulus to weight ratio, and the controllability of the structural properties with the variation of fiber orientation, stacking scheme and the number of laminates. Among the various aspects of the structural performance of structures made of composite materials is the mechanical behavior of rectangular laminated plates which has drawn much attention. In particular, consideration of the buckling phenomena in such plates is essential for the efficient and reliable design

and for the safe use of the structural element. Due to the anisotropic and coupled material behavior, the analysis of composite laminated plates is generally more complicated than the analysis of homogeneous isotropic ones.

The members and structures composed of laminated composite material are usually very thin, and hence more prone to buckling. Buckling phenomenon is critically dangerous to structural components because the buckling of composite plates usually occurs at a lower applied stress and generates large deformations. This led to a focus on the study of buckling behavior in composite materials. General introductions to the buckling of elastic structures and of laminated plates can be found in e.g. Refs. {[33] – [46]}. However, these available Curves and data are restricted to idealized loading, namely, uniaxial or biaxial uniform compression.

Due to the importance of buckling considerations, there is an overwhelming number of investigations available in which corresponding stability problems are considered by a wide variety of analysis methods which may be of a closed – form analytical nature or may be sorted into the class of semi – analytical or purely numerical analysis method.

Closed – form exact solutions for the buckling problem of rectangular composite plates are available only for limited combinations of boundary conditions and laminated schemes. These include cross – ply symmetric and angle – ply anti – symmetric rectangular laminates with at least two opposite edges simply supported, and similar plates with two opposite edges clamped but free to deflect (i.e. guided clamp) or with one edge simply supported and the opposite edge with a guided clamp. Most of the exact solutions discussed in the monographs of Whitney [47] who developed an exact solution for critical buckling of solid rectangular orthotropic plates with all edges simply supported , and of Reddy {[48] – [51]} and Leissa and Kang [52],and that of Refs.[39] and [53]. Bao et al. [54] developed an exact solution for two edges simply supported and two edges clamped, and Robinson [55] who developed an exact solution for the critical buckling stress of an orthotropic sandwich plate with all edges simply supported.

For all other configurations, for which only approximated results are available, several semi – analytical and numerical techniques have been developed. The Rayleigh – Ritz method [53] and [56], the finite strip method (FSM) [36] and [57], the element free Galerkin method (EFG) [58], the differential quadrature technique [59], the moving least square differential quadrature method [60] and the most extensively used finite element method (FEM) [61] are the most common ones.

The Kantorovich method (KM) {[62] – [64]}, which is a different and in most cases advantageous semi – analytical method, combines a variation approach of closed – form solutions and an iterative procedure. The method assumes a solution in the form of a sum of products of functions in one direction and functions in the other direction. Then, by assuming the function in one direction, the variation problem of the plate reduces to a set of ordinary differential equations. In the case of buckling analysis, the variation problem reduces to an ordinary differential eigenvalue and eigenfunction problem. The solution of the resulting problem is an approximate one, and its accuracy depends on the assumed functions in the first direction. The extended Kantorovich method (EKM), which was proposed by Kerr [65], is the starting point for an iterative procedure, where the solution obtained in one direction is used as the assumed functions in the second direction. After repeating this process several times, convergence is obtained. The single term extended Kantorovich method was employed for a buckling analysis of rectangular plates by several researches. Eienberger and Alexandrov [66] used the method for the buckling analysis of isotropic plates with variable thickness. Shufrin and Eisenberger [67] and [68] extended the solution to thick plates with constant and variable thickness using the first and higher order shear deformation theories. Ungbhakorn and Singhatanadgid [69] extended the solution to buckling of symmetrically cross – ply laminated rectangular plates. The multi – term formulation of the extended Kantorovich approach to the simplest samples of rectangular isotropic plates was presented by Yuan and Jin [70]. This study showed that the additional terms in the expansion can be used in order to improve the solution.

March and Smith [71] found an approximate solution for all edges clamped. Also, Chang et al. [72] developed approximate solution to the buckling of rectangular orthotropic sandwich plate with two edges simply supported and two edges clamped or all edges clamped using the March – Erickson method and an energy technique. Jiang et al. [73] developed solutions for local buckling of rectangular orthotropic hat – stiffened plates with edges parallel to the stiffeners were simply supported or clamped and edges parallel to the stiffeners were free, and Smith [74] presented solutions bounding the local buckling of hat stiffened plates by considering the section between stiffeners as simply supported or clamped plates.

Many authors have used finite element method to predict accurate in – plane stress distribution which is then used to solve the buckling problem. Zienkiewicz [75] and Cook [76] have clearly presented an approach for finding the buckling strength of plates by first solving the linear elastic problem for a reference load and then the eigenvalue problem for the smallest eigenvalue which then multiplied by the reference load gives the critical buckling load of the structure. An excellent review of the development of plate finite elements during the past 35 years was presented by Yang et al. [77].

Many buckling analysis of composite plates available in the literature are usually realized parallel with the vibration analyses, and are based on two – dimensional plate theories which may be classified as classical and shear deformable ones. Classical plate theories (CPT) do not take into account the shear deformation effects and over predict the critical buckling loads for thicker composite plates, and even for thin ones with a higher anisotropy. Most of the shear deformable plate theories are usually based on a displacement field assumption with five unknown displacement components. As three of these components corresponded to the ones in CPT, the additional ones are multiplied by a certain function of thickness coordinate and added to the displacements field of CPT in order to take into account the shear deformation effects. Taking these functions as linear and cubic forms leads to the so – called uniform or Mindlin shear deformable plate theory (USDPT) [78], and

parabolic shear deformable plate theories (PSDPT) [79] respectively. Different forms were also employed such as hyperbolic shear deformable plate theory (HSDPT) [80], and trigonometric or sine functions shear deformable plate theory (TSDPT) [81] by researchers. Since these types of shear deformation theories do not satisfy the continuity conditions among many layers of the composite structures, the zig – zag type of the plate theories introduced by Di Sciuva [82], and Cho and Parmeter [83] in order to consider interlaminar stress continuities. Recently, Karama et al. [84] proposed a new exponential function {i.e. exponential shear deformable plate theory (ESDPT)} in the displacement field of the composite laminated structures for the representation of the shear stress distribution along the thickness of the composite structures and compared their result for static and dynamic problem of the composite beams with the sine model.

Within the classical lamination theory, Jones [85] presented a closed – form solution for the buckling problem of cross – ply laminated plates with simply supported boundary conditions. In the case of multi – layered plates subjected to various boundary conditions which are different from simply supported boundary conditions at all of their four edges, the governing equations of the buckling of the composite plates do not admit an exact solution, except for some special arrangements of laminated plates. Thus, for the solution of these types of problems, different analytical and / or numerical methods are employed by various researchers. Baharlou and Leissa [56] used the Ritz method with simple polynomials as displacement functions, within the classical theory, for the problem of buckling of cross and angle – ply laminated plates with arbitrary boundary conditions and different in – plane loads. Narita and Leissa [86] also applied the Ritz method with the displacement components assumed as the double series of trigonometric functions for the buckling problem of generally symmetric laminated composite rectangular plates with simply supported boundary conditions at all their edges. They investigated the critical buckling loads for five different types of loading conditions which are uniaxial compression (UA – C), biaxial compression (BA – C), biaxial compression – tension (BA – CT), and positive and negative shear loadings.

The higher – order shear deformation theories can yield more accurate inter – laminate stress distributions. The introduction of cubic variation of displacement also avoids the need for shear correction displacement. To achieve a reliable analysis and safe design, the proposals and developments of models using higher order shear deformation theories have been considered. Lo et al. [87] and [88] reviewed the pioneering work on the field and formulated a theory which accounts for the effects of transverse shear deformation, transverse strain and non – linear distribution of the in – plane displacements with respect to the thickness coordinate. Third – order theories have been proposed by Reddy {[89] – [92]}, Librescu [93], Schmidt [94], Murty [95], Levinson [96], Seide [97], Murthy [98] , Bhimaraddi [99], Mallikarjuna and Kant [100] , Kant and Pandya [101] , and Phan and Reddy [8], among others. Pioneering work and overviews in the field covering closed – form solutions and finite element models can be found in Reddy [90,102,103], Mallikarjuna and Kant [100], Noor and Burton [104], Bert [105], Kant and Kommineni [106], and Reddy and Robbins [107] among others.

For the buckling analysis of the cross – ply laminated plates subjected to simply supported boundary conditions at their opposite two edges and different boundary conditions at the remaining ones Khdeir [108] and Reddy and Khdeir [51] used a parabolic shear deformation theory and applied the state – space technique. Hadian and Nayfeh [109], on the basis of the same theory and for the same type of problem, needed to modify the technique due to ill – conditioning problems encountered especially for thin and moderately thick plates. The buckling analyses of completely simply supported cross – ply laminated plates were presented by Fares and Zenkour [110], who added a non – homogeneity coefficient in the material stiffnesses within various plate theories , and by Matsunaga [111] who employed a global higher order plate theory. Gilat et al. [112] also investigated the same type of problem on the basic of a global – local plate theory where the displacement field is composed of global and local contributions, such that the requirement of the continuity conditions and delaminations effects can be incorporated into formulation.

Many investigations have been reported for static and stability analysis of composite laminates using different traditional methods. Pagano [113] developed an exact three – dimensional (3 – D) elasticity solution for static analysis of rectangular bi – directional composites and sandwich plates. Noor [114] presented a solution for stability of multi – layered composite plates based on 3 – D elasticity theory by solving equations with finite difference method. Also, 3 – D elasticity solutions are presented by GU and Chattopadhyay [115] for the buckling of simply supported orthotropic composite plates. When the problem is reduced from a three – dimensional one (3 – D) to a two dimensional case to contemplate more efficiently the computational analysis of plate composite structures, the displacement based theories and the corresponding finite element models receive the most attention [116].

Bifurcation buckling of laminated structures has been investigated by many researchers without considering the flatness before buckling [117]. This point was first clarified for laminated composite plates for some boundary conditions and for some lamina configurations by Leissa [117]. Qatu and Leissa [118] applied this result to identify true buckling behavior of composite plates. Elastic bifurcation of plates have been extensively studied and well documented in standard texts e.g. [33] and [119], research monographs {[120] – [122]} and journal papers {[123] – [126]}.

It is important to recognize that, with the advent of composite media, certain new material imperfections can be found in composite structures in addition to the better – known imperfections that one finds in metallic structures. Thus, broken fibers, delaminated regions, cracks in the matrix material, as well as holes, foreign inclusions and small voids constitute material and structural imperfections that can exist in composite structures. Imperfections have always existed and their effect on the structural response of a system has been very significant in many cases. These imperfections can be classified into two broad categories: initial geometrical imperfections and material or constructional imperfections.

The first category includes geometrical imperfections in the structural configuration (such as a local out of roundness of a circular cylindrical shell, which makes the cylindrical shell non – circular; a small initial curvature in a flat plate or rod, which makes the structure non – flat, etc.), as well as imperfections in the loading mechanisms (such as load eccentricities; an axially loaded column is loaded at one end in such a manner that a bending moment exists at that end). The effect of these imperfections on the response of structural systems has been investigated by many researchers and the result of these efforts can be easily found in books [3], as well in published papers [127] – [144].

The second class of imperfections is equally important, but has not received as much attentions as the first class; especially as far as its effect on the buckling response characteristics is concerned. For metallic materials, one can find several studies which deal with the effect of material imperfections on the fatigue life of the structural component. Moreover, there exist a number of investigations that deal with the effect of cut – outs and holes on the stress and deformation response of thin plates. Another material imperfection is the rigid inclusion. The effect of rigid inclusions on the stress field of the medium in the neighborhood of the inclusion has received limited attention. The interested reader is referred to the bibliography of Professor Naruoka [127].

There exists two important classes of material and constructional – type imperfections, which are very important in the safe design, especially of aircraft and spacecraft. These classes consist of fatigue cracks or cracks in general and delaminations in systems that employ laminates (i.e. fiber – reinforced composites). There is considerable work in the area of stress concentration at crack tips and crack propagation. Very few investigations are cited, herein, for the sake of brevity. These include primarily those dealing with plates and shells and non – isotropic construction. Some deal with cracks in metallic plates and shells {[145] – [148]}. Others deal with non – isotropic construction and investigate the effects of non –

isotropy {[149] – [154]}. In all of these studies, there is no mention of the effect of the crack presence on the overall stability or instability of the system.

Finally, delaminations are one of the most commonly found defects in laminated structural components. Most of the work found in the literature deals with flat configurations.

Composite structures often contain delaminations. Causes of delamination are many and include tool drops, bird strikes, runway debris hits and manufacturing defects. Moreover, in some cases, especially in the vicinity of holes or close to edges in general, delaminations start because of the development of interlaminar stresses. Several analyses have been reported on the subject of edge delamination and its importance in the design of laminated structures. A few of these works are cited {[155] – [161]}. These and their cited references form a good basis for the interested reader. The type of delamination that comprises the basic and primary treatise is the one that is found to be present away from the edges (internal). This delaminating could be present before the laminate is loaded or it could develop after loading because of foreign body (birds, micrometer, and debris) impact. This is an extremely important problem especially for laminated structures that are subject to destabilizing loads (loads that can induce instability in the structure and possibly cause growth of the delamination; both of these phenomena contribute to failure of the laminate). The presence of delamination in these situations may cause local buckling and / or trigger global buckling and therefore induce a reduction in the overall load – bearing capacity of the laminated structure. The problem, because of its importance, has received considerable attention.

In the present study, the composite media are assumed free of imperfections i.e. initial geometrical imperfections due to initial distortion of the structure, and material and / or constructional imperfections such as broken fibers, delaminated regions, cracks in the matrix material, foreign inclusions and small voids which are due to inconvenient selection of fibers / matrix materials and manufacturing defects. Therefore, the fibers and matrix are assumed perfectly bonded.

CHAPTER (3)

3. Mathematical Formulations and Numerical Modeling

3.1 Introduction:

The following assumptions were made in developing the mathematical formulations of laminated plates: Refer to references [162] – [165].

1. All layers behave elastically;
2. Displacements are small compared with the plate thickness;
3. Perfect bonding exists between layers;
4. The laminate is equivalent to a single anisotropic layer;
5. The plate is flat and has a constant thickness;
6. The plate buckles in a vacuum and all kinds of damping are neglected.

Unlike homogeneous plates, where the coordinates are chosen solely based on the plate shape, coordinates for laminated plates should be chosen carefully. There are two main factors for the choice of the coordinate system. The first factor is the shape of the plate. Where rectangular plates will be best represented by the choice of rectangular (i.e. Cartesian) coordinates. It will be relatively easy to represent the boundaries of such plates with coordinates. The second factor is the fiber orientation or orthotropy. If the fibers are set straight within each lamina, then rectangular orthotropy would result. It is possible to set the fibers in a radial and circular fashion, which would result in circular orthotropy. Indeed, the fibers can also be set in elliptical directions, which would result in elliptical orthotropy.

The choice of the coordinate system is of critical importance for laminated plates. This is because plates with rectangular orthotropy could be set on rectangular, triangular, circular or other boundaries. Composite materials with rectangular orthotropy are the most popular, mainly because of their ease in design and manufacturing. The equations that follow are developed for materials with rectangular orthotropy.

Fig. 3.1 below shows the geometry of a plate with rectangular orthotropy drawn in the cartesian coordinates X, Y, and Z or 1, 2, and 3. The parameters used in such a plate are: (1) the length in the X-direction, (a); (2) the length in the Y – direction (i.e. breadth), (b); and (3) the length in the Z – direction (i.e. thickness), (h).

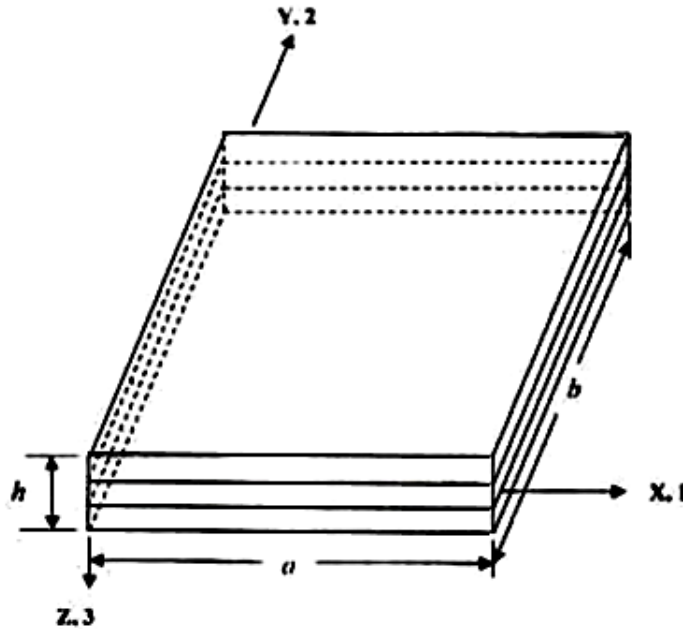

Fig. 3.1 The geometry of a laminated composite plate

3.2 Fundamental Equations of Elasticity:

A first – order shear deformation theory (FSDT) is selected to formulate the problem. Consider a thin plate of length a, breadth b, and thickness h as shown in Fig. 3.2(a), subjected to in – plane loads R_x , R_y and R_{xy} as shown in Fig. 3.2(b). The in – plane displacements $u(x, y, z)$ and $v(x, y, z)$ can be expressed in terms of the out of plane displacement $w(x, y)$ as shown below:

The displacements are:

$$\left. \begin{aligned} u(x, y, z) &= u_o(x, y) - z \frac{\partial w}{\partial x} \\ v(x, y, z) &= v_o(x, y) - z \frac{\partial w}{\partial y} \\ w(x, y, z) &= w_o(x, y) \end{aligned} \right\} \quad (3.1)$$

Where u_o , v_o and w_o are mid – plane displacements in the direction of the x , y and z axes respectively; z is the perpendicular distance from mid – plane to the layer plane.

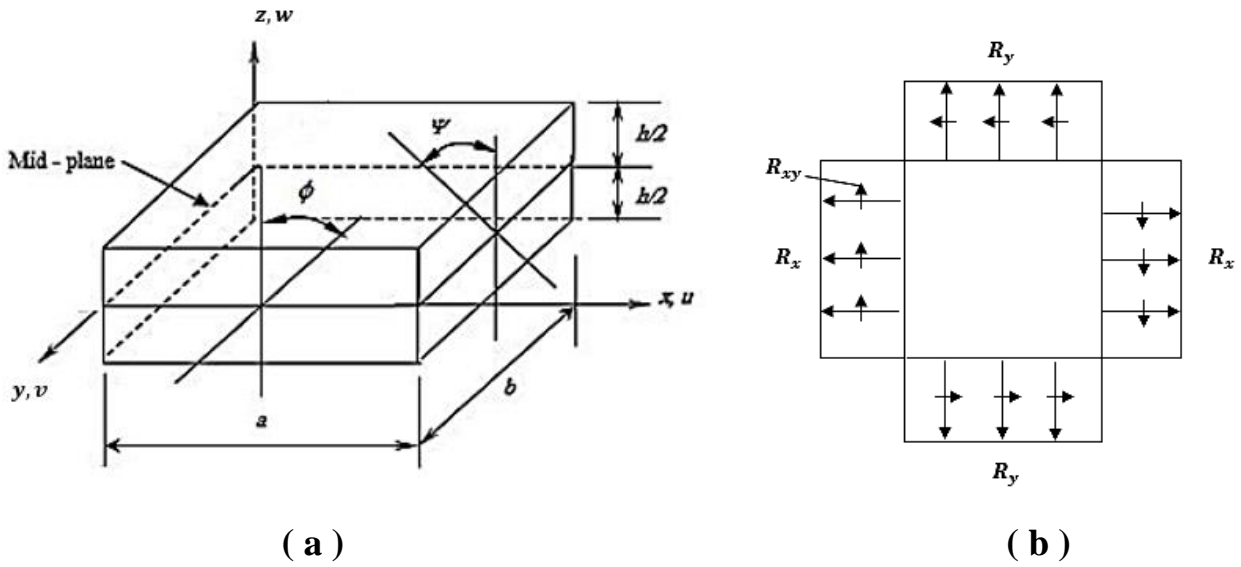

Fig. 3.2

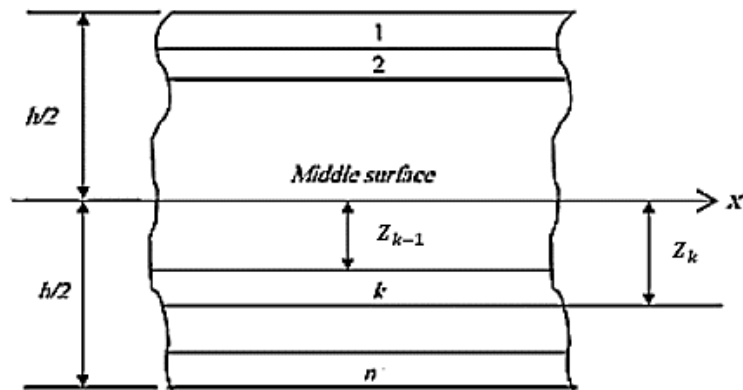

Fig. 3.3 Geometry of an n -Layered laminate

The plate shown in Fig. 3.2 (a) is constructed of an arbitrary number of orthotropic layers bonded together as in Fig. 3.3 above.

The strains are:

$$\left. \begin{aligned} \epsilon_x &= \frac{\partial u_o}{\partial x} - z \frac{\partial^2 w}{\partial x^2} + \frac{1}{2} \left(\frac{\partial w}{\partial x} \right)^2 \\ \epsilon_y &= \frac{\partial v_o}{\partial y} - z \frac{\partial^2 w}{\partial y^2} + \frac{1}{2} \left(\frac{\partial w}{\partial y} \right)^2 \\ \gamma &= \frac{\partial v_o}{\partial x} + \frac{\partial u_o}{\partial y} - 2z \frac{\partial^2 w}{\partial x \partial y} + \left(\frac{\partial w}{\partial x} \right) \left(\frac{\partial w}{\partial y} \right) \end{aligned} \right\} \quad (3.2)$$

The virtual strains:

$$\left. \begin{aligned} \delta\epsilon_x &= \frac{\partial}{\partial x} \delta u_o - z \frac{\partial^2}{\partial x^2} \delta w + \frac{\partial w}{\partial x} \frac{\partial}{\partial x} \delta w \\ \delta\epsilon_y &= \frac{\partial}{\partial y} \delta v_o - z \frac{\partial^2}{\partial y^2} \delta w + \frac{\partial w}{\partial y} \frac{\partial}{\partial y} \delta w \\ \delta\gamma &= \frac{\partial}{\partial x} \delta v_o + \frac{\partial}{\partial y} \delta u_o - 2z \frac{\partial^2}{\partial x \partial y} \delta w + \frac{\partial w}{\partial x} \frac{\partial}{\partial y} \delta w + \frac{\partial}{\partial x} \delta w \frac{\partial w}{\partial y} \end{aligned} \right\} \quad (3.3)$$

The virtual strain energy:

$$\delta U = \int_V \delta \epsilon^T \sigma dV \quad (3.4)$$

But,

$$\sigma = C \epsilon$$

Where,

$$C = C_{ij} (i, j = 1, 2, 6)$$

$$\therefore \delta U = \int_V \delta \epsilon^T C \delta \epsilon dV \quad (3.5)$$

If we neglect the in plane displacements u_o and v_o and considering only the linear terms in the strain – displacement equations, we write:

$$\delta \epsilon = -z \begin{vmatrix} \frac{\partial^2}{\partial x^2} \\ \frac{\partial^2}{\partial y^2} \\ 2 \frac{\partial^2}{\partial x \partial y} \end{vmatrix} \delta w \quad (3.6)$$

3.3 The Numerical Method:

The finite element is used in this analysis as a numerical method to predict the buckling loads and shape modes of buckling of laminated rectangular plates. In this method of analysis, four – noded type of elements is chosen. These elements are the four – noded bilinear rectangular elements of a plate. Each element has three degrees of freedom at each node. The degrees of freedom are the lateral displacement (w), and the rotations (ϕ) and (ψ) about the (X) and (Y) axes respectively.

The secondary effects of shear deformation, are also considered in the present method. The shear deformation is formulated by the first – order shear deformation theory (FSDT). The finite element method is formulated by the energy method. The numerical method can be summarized in the following procedures:

1. The choice of the element and its shape functions.
2. Formulation of finite element model by the energy approach to develop both element stiffness and differential matrices.
3. Employment of the principles of non – dimensionality to convert the element matrices to their non – dimensionalized forms.
4. Assembly of both element stiffness and differential matrices to obtain the corresponding global matrices.
5. Introduction of boundary conditions as required for the plate edges.
6. Suitable software can be used to solve the problem (here two software were utilized, FORTRAN and ANSYS).

For an n noded element, and 3 degrees of freedom at each node.

Now express w in terms of the shape functions N (give in Appendix (B)) and noded displacements a^e , equation (3.6) can be written as:

$$\delta\epsilon = -zB\delta a^e \quad (3.7)$$

Where,

$$B^T = \left[\frac{\partial^2 N_i}{\partial x^2} \quad \frac{\partial^2 N_i}{\partial y^2} \quad z \frac{\partial^2 N_i}{\partial x \partial y} \right]$$

and

$$a^e = [w_i] \quad i = 1, n$$

The stress – strain relation is:

$$\sigma = C \epsilon$$

Where c are the material properties which could be written as follows:

$$C = \begin{bmatrix} C_{11} & C_{12} & C_{16} \\ C_{12} & C_{22} & C_{26} \\ C_{16} & C_{26} & C_{66} \end{bmatrix}$$

Where C_{ij} are given in Appendix (A).

$$\delta U = \int_V (B\delta a^e)^T (CZ^2) B a^e dV$$

Where V denotes volume.

$$\delta U = \delta a^{eT} \int_V B^T D B a^e dx dy = \delta a^{eT} K^e a^e \quad (3.8)$$

Where $D_{ij} = \sum_{k=1}^n \int_{Z_{k-1}}^{Z_k} C_{ij} Z^2 dZ$ is the bending stiffness, and K^e is the element stiffness matrix which could be written as:

$$K^e = \int B^T D B dx dy \quad (3.9)$$

The virtual work done by external forces can be expressed as follows: Refer to Fig. (3.4).

Denoting the nonlinear part of strain by $\delta\epsilon'$

$$\delta W = \iint \delta\epsilon'^T \sigma' dV = \int \delta\epsilon'^T \bar{N} dx dy \quad (3.10)$$

Where

$$N^T = [N_x \ N_y \ N_{xy}] = [\sigma_x \ \sigma_y \ \tau] dZ$$

$$\delta\epsilon' = \begin{bmatrix} \delta\epsilon_x \\ \delta\epsilon_y \\ \delta\gamma \end{bmatrix} = \begin{bmatrix} \frac{\partial}{\partial x} \delta w & 0 \\ 0 & \frac{\partial}{\partial y} \delta w \\ \frac{\partial}{\partial y} \delta w & \frac{\partial}{\partial x} \delta w \end{bmatrix} \begin{bmatrix} \frac{\partial w}{\partial x} \\ \frac{\partial w}{\partial y} \end{bmatrix} \quad (3.11)$$

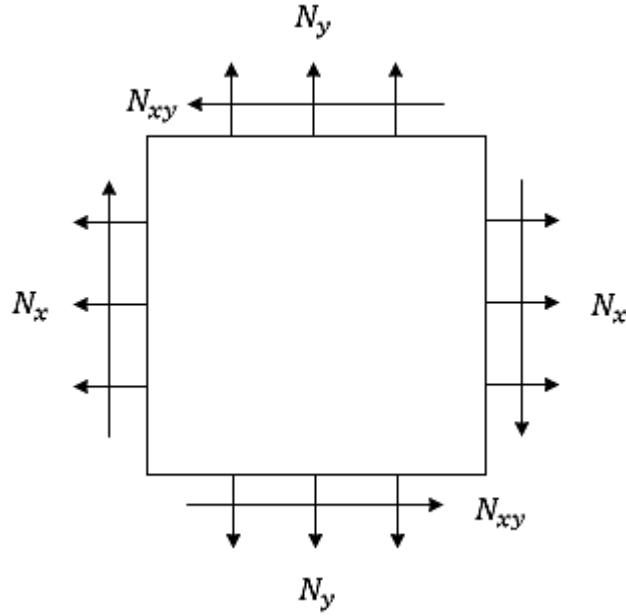

Fig. 3.4 External forces acting on an element

Hence

$$\delta W = \iint \begin{bmatrix} \frac{\partial w}{\partial x} \\ \frac{\partial w}{\partial y} \end{bmatrix}^T \begin{bmatrix} \frac{\partial}{\partial x} \delta w & 0 & \frac{\partial}{\partial y} \delta w \\ 0 & \frac{\partial}{\partial y} \delta w & \frac{\partial}{\partial x} \delta w \end{bmatrix} \begin{bmatrix} N_x \\ N_y \\ N_{xy} \end{bmatrix} dx dy \quad (3.12)$$

This can be written as:

$$\delta W = \iint \begin{bmatrix} \frac{\partial}{\partial x} \delta w \\ \frac{\partial}{\partial y} \delta w \end{bmatrix}^T \begin{bmatrix} N_x & N_{xy} \\ N_{xy} & N_y \end{bmatrix} \begin{bmatrix} \frac{\partial w}{\partial x} \\ \frac{\partial w}{\partial y} \end{bmatrix} dx dy \quad (3.13)$$

Now $w = N_i a_i^e$

$$\delta W = \delta a^{eT} \iint \begin{bmatrix} \frac{\partial N_i}{\partial x} \\ \frac{\partial N_i}{\partial y} \end{bmatrix}^T \begin{bmatrix} N_x & N_{xy} \\ N_{xy} & N_y \end{bmatrix} \begin{bmatrix} \frac{\partial N_i}{\partial x} \\ \frac{\partial N_i}{\partial y} \end{bmatrix} a^e dx dy \quad (3.14)$$

Substitute $P_x = -N_x, P_y = -N_y, P_{xy} = -N_{xy}$

$$\delta W = -\delta a^{eT} \iint \begin{bmatrix} \frac{\partial N_i}{\partial x} \\ \frac{\partial N_i}{\partial y} \end{bmatrix}^T \begin{bmatrix} P_x & P_{xy} \\ P_{xy} & P_y \end{bmatrix} \begin{bmatrix} \frac{\partial N_i}{\partial x} \\ \frac{\partial N_i}{\partial y} \end{bmatrix} a^e dx dy \quad (3.15)$$

Therefore, equation (3.15) could be written in the following form:

$$\delta W = -\delta a^{eT} K^D a^e \quad (3.16)$$

Where,

$$K^D = \iint \begin{bmatrix} \frac{\partial N_i}{\partial x} \\ \frac{\partial N_i}{\partial y} \end{bmatrix}^T \begin{bmatrix} P_x & P_{xy} \\ P_{xy} & P_y \end{bmatrix} \begin{bmatrix} \frac{\partial N_i}{\partial x} \\ \frac{\partial N_i}{\partial y} \end{bmatrix} dx dy$$

K^D is the differential stiffness matrix known also as geometric stiffness matrix, initial stress matrix, and initial load matrix.

The total energy:

$$\delta U + \delta W = 0 \quad (3.17)$$

Since δa^e is an arbitrary displacement which is not zero, then

$$K^e a^e - K^D a^e = 0 \quad (3.18)$$

Now let us compute the elements of the stiffness and the differential matrices.

$$K^e = \iint B^T D B dx dy$$

$$K^e = \iint \begin{bmatrix} \frac{\partial^2 N_i}{\partial x^2} \\ \frac{\partial^2 N_i}{\partial y^2} \\ 2 \frac{\partial^2 N_i}{\partial x \partial y} \end{bmatrix}^T \begin{bmatrix} D_{11} & D_{12} & D_{16} \\ D_{12} & D_{22} & D_{26} \\ D_{16} & D_{26} & D_{66} \end{bmatrix} \begin{bmatrix} \frac{\partial^2 N_i}{\partial x^2} \\ \frac{\partial^2 N_i}{\partial y^2} \\ 2 \frac{\partial^2 N_i}{\partial x \partial y} \end{bmatrix} dx dy$$

The elements of the stiffness matrix can be expressed as follows:

$$K_{ij}^e = \iint \left[D_{11} \frac{\partial^2 N_i}{\partial x^2} \frac{\partial^2 N_j}{\partial x^2} + D_{12} \frac{\partial^2 N_i}{\partial y^2} \frac{\partial^2 N_j}{\partial x^2} + 2D_{16} \frac{\partial^2 N_i}{\partial x \partial y} \frac{\partial^2 N_j}{\partial x^2} + D_{12} \frac{\partial^2 N_i}{\partial x^2} \frac{\partial^2 N_j}{\partial y^2} \right]$$

$$\begin{aligned}
& D_{22} \frac{\partial^2 N_i}{\partial y^2} \frac{\partial^2 N_j}{\partial y^2} + 2D_{26} \frac{\partial^2 N_i}{\partial x \partial y} \frac{\partial^2 N_j}{\partial y^2} + 2D_{16} \frac{\partial^2 N_i}{\partial x^2} \frac{\partial^2 N_j}{\partial x \partial y} + 2D_{26} \frac{\partial^2 N_i}{\partial y^2} \frac{\partial^2 N_j}{\partial x \partial y} \\
& + 4D_{66} \frac{\partial^2 N_i}{\partial x \partial y} \frac{\partial^2 N_j}{\partial x \partial y} \Big] dx dy \quad (3.19)
\end{aligned}$$

The elements of the differential stiffness matrix can be expressed as follows;

$$K_{ij}^D = \iint \left[P_x \frac{\partial N_i}{\partial x} \frac{\partial N_j}{\partial x} + P_{xy} \left(\frac{\partial N_i}{\partial y} \frac{\partial N_j}{\partial x} + \frac{\partial N_i}{\partial x} \frac{\partial N_j}{\partial y} \right) + P_y \frac{\partial N_i}{\partial y} \frac{\partial N_j}{\partial y} \right] dx dy \quad (3.20)$$

The integrals in equations (3.19) and (3.20) are given in Appendix (C).

The shape functions for a 4 – noded element is shown below in Fig. 3.5.

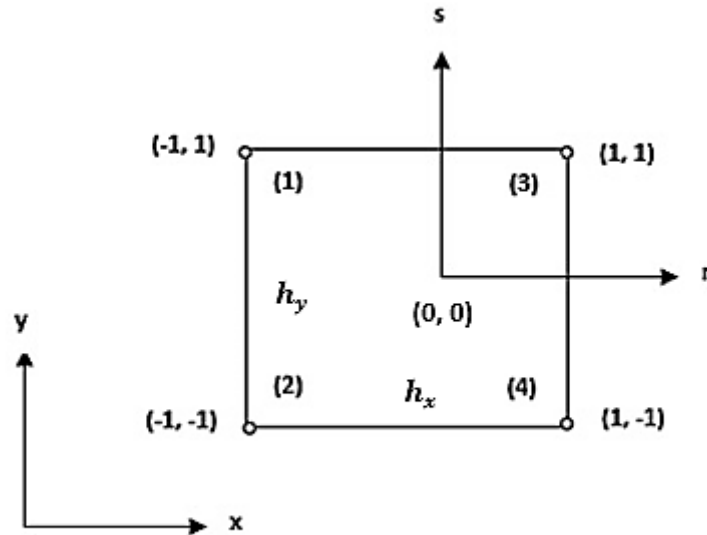

Fig. 3.5 A four noded element with local and global co – ordinates

The shape functions for the 4 – noded element expressed in global co – ordinates (x, y) are as follows:

$$\begin{aligned}
w = & N_1 w_1 + N_2 \phi_1 + N_3 \psi_1 + N_4 w_2 + N_5 \phi_2 + N_6 \psi_2 \\
& + N_7 w_3 + N_8 \phi_3 + N_9 \psi_3 + N_{10} w_4 + N_{11} \phi_4 + N_{12} \psi_4
\end{aligned}$$

Where,

$$\phi = \frac{\partial w}{\partial x}, \quad \psi = \frac{\partial w}{\partial y}$$

The shape functions in local co – ordinates are as follows:

$$N_i = a_{i1} + a_{i2}r + a_{i3}s + a_{i4}r^2 + a_{i5}rs + a_{i6}s^2 + a_{i7}r^3 + a_{i8}r^2s + a_{i9}rs^2 \\ + a_{i10}s^3 + a_{i11}r^3s + a_{i12}rs^3$$

$$N_j = a_{j1} + a_{j2}r + a_{j3}s + a_{j4}r^2 + a_{j5}rs + a_{j6}s^2 + a_{j7}r^3 + a_{j8}r^2s + a_{j9}rs^2 \\ + a_{j10}s^3 + a_{j11}r^3s + a_{j12}rs^3$$

The values of the coefficients a_{ij} are given in the table in Appendix (B).

$$q_1 = \iint \frac{\partial^2 N_i}{\partial r^2} \frac{\partial^2 N_j}{\partial r^2} dr ds = 16 \left[a_{i4}a_{j4} + 3a_{i7}a_{j7} + \frac{1}{3}a_{i8}a_{j8} + a_{i11}a_{j11} \right]$$

$$q_2 = \iint \frac{\partial^2 N_i}{\partial s^2} \frac{\partial^2 N_j}{\partial s^2} dr ds = 16 \left[a_{i6}a_{j6} + \frac{1}{3}a_{i9}a_{j9} + 3a_{i10}a_{j10} + a_{i12}a_{j12} \right]$$

$$q_3 = \iint \frac{\partial^2 N_i}{\partial r^2} \frac{\partial^2 N_j}{\partial s^2} dr ds = 16 \left[a_{i4}a_{j6} + a_{i7}a_{j9} + a_{i8}a_{j10} + a_{i11}a_{j12} \right]$$

$$q_4 = \iint \frac{\partial^2 N_i}{\partial s^2} \frac{\partial^2 N_j}{\partial r^2} dr ds = 16 \left[a_{i6}a_{j4} + a_{i9}a_{j7} + a_{i10}a_{j8} + a_{i12}a_{j11} \right]$$

$$q_5 = \iint \frac{\partial^2 N_i}{\partial r^2} \frac{\partial^2 N_j}{\partial r \partial s} dr ds = 8 \left[a_{i4}a_{j5} + a_{i4}a_{j11} + 2a_{i7}a_{j8} + a_{i4}a_{j12} \right. \\ \left. + \frac{2}{3}a_{i4}a_{j5} \right]$$

$$q_6 = \iint \frac{\partial^2 N_i}{\partial r \partial s} \frac{\partial^2 N_j}{\partial r^2} dr ds = 8 \left[a_{i5}a_{j4} + 2a_{i8}a_{j7} + a_{i11}a_{j4} + \frac{2}{3}a_{i9}a_{j8} \right. \\ \left. + a_{i12}a_{j4} \right]$$

$$q_7 = \iint \frac{\partial^2 N_i}{\partial s^2} \frac{\partial^2 N_j}{\partial r \partial s} dr ds = 8 \left[a_{i6}a_{j5} + a_{i6}a_{j11} + \frac{2}{3}a_{i9}a_{j8} \right]$$

$$q_8 = \iint \frac{\partial^2 N_i}{\partial r \partial s} \frac{\partial^2 N_j}{\partial s^2} dr ds = 8 \left[a_{i5}a_{j6} + \frac{2}{3}a_{i8}a_{j9} + a_{i11}a_{j6} \right]$$

$$q_9 = \iint \frac{\partial^2 N_i}{\partial r \partial s} \frac{\partial^2 N_j}{\partial r \partial s} dr ds = 4 \left[a_{i5}a_{j5} + a_{i5}a_{j11} + \frac{4}{3}a_{i8}a_{j8} + a_{i5}a_{j12} \right. \\ \left. + \frac{4}{3}a_{i9}a_{j9} + a_{i11}a_{j12} + a_{i12}a_{j11} + \frac{9}{5}a_{i12}a_{j12} \right]$$

$$\begin{aligned}
q_{10} &= \iint \frac{\partial N_i}{\partial r} \frac{\partial N_j}{\partial r} dr ds = 4 \left[a_{i2} a_{j2} + \frac{1}{3} (3a_{i2} a_{j7} + 4a_{i4} a_{j4} + 3a_{i7} a_{j2} \right. \\
&+ a_{i7} a_{j9} + a_{i5} a_{j5} + a_{i5} a_{j5} + a_{i9} a_{j2} + a_{i5} a_{j11} + a_{i7} a_{j9} + \frac{4}{3} a_{i8} a_{j8} + a_{i9} a_{j7} \\
&a_{i11} a_{j5}) + \frac{1}{5} (a_{i5} a_{j12} + a_{i9} a_{j9} + a_{i12} a_{j5} + 9a_{i7} a_{j7} + 3a_{i11} a_{j11} + a_{i11} a_{j12} \\
&\quad \left. + a_{i12} a_{j11}) + \frac{1}{7} a_{i12} a_{j12} \right] \\
q_{11} &= \iint \frac{\partial N_i}{\partial s} \frac{\partial N_j}{\partial s} dr ds = 4 \left[a_{i3} a_{j3} + \frac{1}{3} (a_{i3} a_{j8} + a_{i5} a_{j5} + a_{i8} a_{j3} + 3a_{i3} a_{j10} \right. \\
&+ 4a_{i6} a_{j6} + 3a_{i10} a_{j3} + a_{i5} a_{j12} + a_{i8} a_{j10} + \frac{4}{3} a_{i9} a_{j9} + a_{i10} a_{j8} + a_{i12} a_{j5}) \\
&+ \frac{1}{5} (a_{i5} a_{j11} + a_{i8} a_{j8} + a_{i11} a_{j5} + 9a_{i10} a_{j10} + a_{i11} a_{j12} + a_{i12} a_{j11} + 3a_{i2} a_{j12}) \\
&\quad \left. + \frac{1}{7} a_{i11} a_{j11} \right] \\
q_{12} &= \iint \frac{\partial N_i}{\partial r} \frac{\partial N_j}{\partial r} dr ds = 4 \left[a_{i2} a_{j3} + \frac{1}{3} (3a_{i2} a_{j8} + 2a_{i4} a_{j5} + 3a_{i7} a_{j8} \right. \\
&+ 3a_{i2} a_{j10} + 2a_{i5} a_{j6} + a_{i9} a_{j3} + 2a_{i4} a_{j12} + 3a_{i7} a_{j10} + \frac{4}{3} a_{i8} a_{j9} + \frac{1}{3} a_{i9} a_{j8} \\
&\quad \left. + 2a_{i11} a_{j6}) \right] \\
q_{13} &= \iint \frac{\partial N_i}{\partial s} \frac{\partial N_j}{\partial r} dr ds = 4 \left[a_{i3} a_{j2} + \frac{1}{3} (3a_{i3} a_{j7} + 2a_{i5} a_{j4} + a_{i8} a_{j2} \right. \\
&+ a_{i3} a_{j9} + 2a_{i6} a_{j5} + 3a_{i10} a_{j2} + 2a_{i6} a_{j11} + \frac{1}{3} a_{i8} a_{j9} + \frac{4}{3} a_{i9} a_{j8} + 3a_{i10} a_{j7} \\
&\quad \left. + 2a_{i12} a_{j4}) + \frac{1}{5} (2a_{i6} a_{j12} + 3a_{i10} a_{j9} + 3a_{i8} a_{j7} + 2a_{i11} a_{j4}) \right]
\end{aligned}$$

The values of the integrals are converted from local co – ordinate (r, s) to global co – ordinates as follows:

$$r_1 = \iint \frac{\partial^2 N_i}{\partial x^2} \frac{\partial N_j}{\partial x^2} dx dy = \left(\frac{4h_y}{h_x^3} \right) q_1 = \frac{4n^3 b}{ma^3} q_1$$

$$r_2 = \iint \frac{\partial^2 N_i}{\partial y^2} \frac{\partial^2 N_j}{\partial y^2} dx dy = \left(\frac{4h_x}{h_y^3} \right) q_2 = \frac{4am^3}{nb^3} q_2$$

$$r_3 = \iint \frac{\partial^2 N_i}{\partial x^2} \frac{\partial^2 N_j}{\partial y^2} dx dy = \left(\frac{4}{h_y h_x} \right) q_3 = \frac{4mn}{ab} q_3$$

$$r_4 = \iint \frac{\partial^2 N_i}{\partial y^2} \frac{\partial^2 N_j}{\partial x^2} dx dy = \left(\frac{4}{h_y h_x} \right) q_4 = \frac{4mn}{ab} q_4$$

$$r_5 = \iint \frac{\partial^2 N_i}{\partial x^2} \frac{\partial^2 N_j}{\partial x \partial y} dx dy = \left(\frac{4}{h_x^2} \right) q_5 = \frac{4n^2}{a^2} q_5$$

$$r_6 = \iint \frac{\partial^2 N_i}{\partial x \partial y} \frac{\partial^2 N_j}{\partial x^2} dx dy = \left(\frac{4}{h_x^2} \right) q_6 = \frac{4n^2}{a^2} q_6$$

$$r_7 = \iint \frac{\partial^2 N_i}{\partial y^2} \frac{\partial^2 N_j}{\partial x \partial y} dx dy = \left(\frac{4}{h_y^2} \right) q_7 = \frac{4m^2}{a^2} q_7$$

$$r_8 = \iint \frac{\partial^2 N_i}{\partial x \partial y} \frac{\partial^2 N_j}{\partial y^2} dx dy = \left(\frac{4}{h_y^2} \right) q_8 = \frac{4m^2}{b^2} q_8$$

$$r_9 = \iint \frac{\partial^2 N_i}{\partial x \partial y} \frac{\partial^2 N_j}{\partial x \partial y} dx dy = \left(\frac{4}{h_y h_x} \right) q_9 = \frac{4mn}{ab} q_9$$

$$r_{10} = \iint \frac{\partial N_i}{\partial x} \frac{\partial N_j}{\partial x} dx dy = \left(\frac{h_y}{h_x} \right) q_{10} = \frac{bn}{am} q_{10}$$

$$r_{11} = \iint \frac{\partial N_i}{\partial y} \frac{\partial N_j}{\partial y} dx dy = \left(\frac{h_x}{h_y} \right) q_{11} = \frac{am}{bn} q_{11}$$

$$r_{12} = \iint \frac{\partial N_i}{\partial x} \frac{\partial N_j}{\partial y} dx dy = q_{12}$$

$$r_{13} = \iint \frac{\partial N_i}{\partial y} \frac{\partial N_j}{\partial x} dx dy = q_{13}$$

In the previous equations $h_x = \frac{a}{n}$ and $h_y = \frac{b}{m}$ where a and b are the lengths of the plate along the x – and y – axis respectively. n and m are the number of elements in the x – and y – directions respectively.

The elements of the stiffness matrix and the differential matrix can be written as follows:

$$K_{ij} = D_{11}r_1 + D_{12}r_4 + 2D_{16}r_3 + D_{12}r^3 + D_{22}r_2 + 2D_{66}r_8 + 2D_{16}r_5 + 2D_{26}r_7 + 4D_{66}r_9$$

$$K_{ij}^D = P_x r_{10} + P_{xy}(r_{12} + r_{13}) + P_y r_{11}$$

or in the non – dimensional form

$$K_{ij} = \frac{4n^3}{m} \left(\frac{b}{a}\right) D'_{11} q_1 + 4mn \left(\frac{a}{b}\right) D'_{12} q_4 + 4n^2 D'_{16} q_6 + 4mn \left(\frac{a}{b}\right) D'_{12} q_3 + \frac{4m^3}{n} \left(\frac{a}{b}\right) D'_{22} q_2 + 4m^2 \left(\frac{a}{b}\right)^2 D'_{26} q_8 + 4n^2 D'_{16} q_5 + 4m^2 \left(\frac{a}{b}\right)^2 D'_{26} q_7 + 4mn \left(\frac{a}{b}\right) D'_{66} q_9$$

$$K_{ij}^D = P'_x \frac{n}{m} \left(\frac{b}{a}\right) q_{10} + P'_{xy}(q_{12} + q_{13}) + P'_y \frac{m}{n} \left(\frac{a}{b}\right) q_v$$

where

$$D'_{ij} = \left(\frac{1}{E_2 h^3}\right) D_{ij}, \quad P'_i = \left(\frac{a}{E_2 h^3}\right) P_i$$

The transformed stiffness are as follows:

$$C_{11} = C'_{11}c^4 + 2c^2s^2(C'_{11} + 2C'_{66}) + C'_{22}s^4$$

$$C_{12} = c^2s^2(C'_{11} + C'_{22} + 4C'_{66}) + C'_{12}(c^4 + s^4)$$

$$C_{16} = cs[C'_{11}c^4 + C'_{22}s^2 - (C'_{12} + 2C'_{66})(c^2 - s^2)]$$

$$C_{22} = C'_{11}s^4 + 2c^2s^2(C'_{12} + 2C'_{66}) + C'_{22}c^4$$

$$C_{26} = cs[C'_{11}s^2 + C'_{22}c^2 - (C'_{12} + 2C'_{66})(c^2 - s^2)]$$

$$C_{66} = (C'_{11} + C'_{22} + 2C'_{12})c^2s^2 + C'_{66}(c^2 - s^2)^2$$

Where

$$C'_{11} = \frac{E_1}{1 - \nu_{12}\nu_{21}}$$

$$C'_{12} = \frac{v_{21} E_1}{1 - v_{12}v_{21}} = \frac{v_{12} E_1}{1 - v_{12}v_{21}}$$

$$C'_{22} = \frac{E_2}{1 - v_{12}v_{21}}$$

$$C'_{44} = G_{23}, \quad C'_{55} = G_{13} \quad \text{and} \quad C'_{66} = G_{12}$$

E_1 and E_2 are the elastic moduli in the direction of the fiber and the transverse directions respectively, ν is the Poisson's ratio. G_{12} , G_{13} , and G_{23} are the shear moduli in the $x - y$ plane, $y - z$ plane, and $x - z$ plane respectively, and the subscripts 1 and 2 refer to the direction of fiber and the transverse direction respectively.

CHAPTER (4)

Conclusion

A composite material can be defined as a combination of two or more materials that gives better properties than those of the individual components used alone. In contrast to metallic alloys, each material retains its separate chemical, physical and mechanical properties. The two constituents are reinforcement and a matrix. The main advantages of composite materials are their high strength and stiffness combined with low density when compared to classical materials. Micromechanical approach is found to be more suitable for the analysis of composite materials because it studies the volume proportions of the constituents (i.e. fibers and matrix) for the desired lamina stiffness and strength.

A comprehensive literature review on different theories of laminated plates have been reviewed and discussed thoroughly. It has been found that there are two main theories of laminated plates which are known as linear and nonlinear theories. The two theories are depending on the magnitude of deformation resulting from loading the given plates. The difference between the two theories is that deformations are small in the linear theory, whereas they are finite or large in the nonlinear theory.

In comparisons survey between finite element method (FEM) and different numerical and / or analytical methods it has been found that FEM can be considered of acceptable accuracy, and can also be applied to different complicated geometries and shapes.

Comprehensive bibliography and literature review on buckling of composite laminated plates were presented and discussed thoroughly. Exact, analytical and semi – analytical solutions in buckling of laminates were analyzed using different factors which include boundary conditions, plate dimensions and lamination scheme. Development of plate theories from classical plate theory through first order shear deformation, and to higher order shear deformation theories were considered in the analysis of buckling. It was found that higher order shear deformation theories can yield more accurate inter – laminate stresses and also avoids the need for shear correction displacement.

Mathematical formulation and numerical modeling of laminated composite plates subjected to in – plane buckling load were derived and discussed thoroughly.

In most of the previous studies, the composite media are assumed free of imperfections and therefore, they are neglected in mathematical analyses. It is found that the manufacturing processes of composite laminated plates are responsible of the many defects which may arise in fibers, matrix and lamina. These defects, if they exist include misalignment of fibers in the matrix, voids in fibers and matrix, delaminated regions, and initial stress in the lamina as a result of its manufacture and further treatment. These defects tend to propagate as the lamina is loaded causing an accelerated rate of failure. The experimental and theoretical results in this case tend to differ. Hence, due to the limitations necessary in the idealization of the lamina components, the properties estimated should be proved experimentally.

BIBLIOGRAPHY:

- [1] David Roylance, 'an introduction to composite materials', Department of material science and engineering, Massachusetts Institute of Technology, Cambridge; (2000).
- [2] Stephen W. Tsai, Thomas Hahn H., 'introduction to composite materials', Technomic publishing company; (1980).
- [3] Turvey G.J., Marshall I.H., 'buckling and post buckling of composite plates', Great Britain, T.J. press Ltd, Padstow, Cornwall; (1995).
- [4] Vernon B. John, 'introduction to engineering materials', second edition; (1972).
- [5] Jan Stegmann and Erik Lund, 'notes on structural analysis of composite shell structures', Aalborg University, Denmark; (2001).
- [6] Reddy J.N., 'A simple higher – order theory for laminated composite plates', Journal of applied mechanics, vol. 51, No. 745; (1984),pp.(13–19).
- [7] Mindlin R.D., 'Influence of rotatory inertia and shear on flexural motions of isotropic elastic plates', Journal of applied mechanics; (1951), PP. (31–38).
- [8] Phan N.D. and Reddy J.N., 'Analysis of laminated composite plate using higher – order shear deformation theory', International Journal of numerical methods in engineering, vol.21; (1985), pp. (2201–2219).
- [9] Constance P. Yang, Charles H. Norris and Yehuda Stavsky,' Elastic wave propagation in heterogeneous plates', International Journal of solids and structures, vol.2 ;(1966).PP. (665 – 684).
- [10] Whitney J.M. and Pagano N.J., ' Shear deformation in heterogeneous anisotropic plates', Journal of applied mechanics, vol.4; (1970), PP. (1031 – 1036).
- [11] Seloodeh A.R., Karami G.,' Static, free vibration and buckling analysis of anisotropic thick laminated composite plates on distributed and point elastic supports using a 3–D layer-wise FEM', Engineering structures (26); (2004),pp.(211–220).
- [12] Noor A.K.,'Free vibration of multi-layered composite plates', AIAA Journal; (1973), 11: PP. (1038–1039).

- [13] Dorguoglu A.N., Omurtag M.H.,' Stability analysis of composite plate foundation interaction by mixed FEM', Journal of engineering mechanics, ASCE; (2000), 126(9):PP. (928–936).
- [14] Huang M.H., Thambiratnum D.P.,' Analysis of plate resting on elastic supports and elastic foundation by finite strip method', computers and structures; (2001), 79: PP. (2547–2557).
- [15] Reissner E. and Stavsky Y.,' Bending and stretching of certain types of heterogeneous Aeolotropic plates', Journal of applied mechanics, vol.28; (1961), PP. (402– 408).
- [16] Srinivas S. and Rao A.K.,' Bending, vibration and buckling of simply supported thick orthotropic rectangular plates and laminates', vol.6; (1970), PP. (1463 –1481).
- [17] Turvey G.J. and Osman M.Y.,' Elastic large deflection analysis of isotropic rectangular Mindlin plates', International Journal of mechanical sciences, vol.22; (1990), PP. (1 –14).
- [18] Turvey G.J. and Osman M.Y., 'Large deflection analysis of orthotropic Mindlin plates', proceedings of the 12th Energy resource technology conference and exhibition, Houston, Texas; (1989),PP.(163–172).
- [19] Turvey G.J. and Osman M.Y.,' Large deflection effects in anti-symmetric cross-ply laminated strips and plates', I.H. Marshall, composite structures,vol.6, Paisley College, Scotland, Elsevier Science publishers; (1991),PP.(397– 413).
- [20] Reddy J.N.,' a penalty plate – bending element for the analysis of laminated anisotropic composite plates', International Journal for numerical methods in engineering, vol.15; (1980), PP. (1187–1206).
- [21] Reddy J.N. and Chao W.C.,' Non-linear bending of thick rectangular laminated composite plates', International Journal of non – linear mechanics, vol.16,No. 314;(1981),PP.(291–301).

- [22] Chia C.Y. and Prabhakara M.K., 'Large deflection of unsymmetrical cross – ply and angle – ply plates', Journal of mechanical engineering science, vol.18,No.4;(1976),PP.(179–183).
- [23] Putcha N.S. and Reddy J.N., 'A refined mixed shear flexible finite element for the non – linear analysis of laminated plates', computers and structures, vol.22, No.4 ;(1986), PP. (529–538).
- [24] Gorji M., 'On large deflection of symmetric composite plates under static loading', Institution of mechanical engineering, vol. 200; (1986). PP. (13–19).
- [25] Zenkour A.M. and Fares M.E., 'Non – homogenous response of cross – ply laminated elastic plates using a higher order theory', Composite structures, vol. 44; (1999), PP. (297 – 305).
- [26] Rushton K.R., 'large deflection of variable thickness plates', International Journal of mechanical sciences, vol.10. ; (1968), PP. (723 – 735).
- [27] Cassell A.C. and Hobbs R.E., 'Numerical stability of dynamic relaxation analysis of nonlinear structures', International Journal for numerical methods in engineering, vol.35, No.4; (1966), PP. (1407 – 1410).
- [28] Day A.S., 'An introduction to dynamic relaxation', the engineer, vol.219, No.5683; (1965).PP. (218 – 221).
- [29] Larry J. Segelind, 'applied finite element analyses', Agricultural engineering department, Michigan state University, John wiley and sons publishers; (1984).
- [30] Amir Wadi Al – Khafaji and John R. Tooley, ' Numerical methods in engineering practice', University of Evansville, CBS publishing Japan Ltd ; (1986).
- [31] Eastop T.D., McConkey A., ' Applied thermodynamics for engineering technologists', fifth edition, John wiley and sons, New York ;(1993).
- [32] Aalami B., 'Large deflection of elastic plates under patch loading', Journal of the structural division, ASCE, vol.98, No.ST 11; (1972), PP. (2567 – 2586).

- [33] Timoshenko S.P., Gere J.M., 'Theory of elastic stability', second edition, New York: McGraw Hill book company, Inc.; (1961).
- [34] Chai G.B., Hoon K.H., 'buckling of generally laminated composite plates', Composite science technology; (1992), 45:PP. (125 – 133).
- [35] Liew K.M., Wang C.M., 'Pb – 2 Rayleigh – Ritz method for general plate analyses', Engineering structures; (1993), 15:PP. (55 – 60).
- [36] Chai G.B., Khong P.W., 'The effect of varying support conditions on the buckling of laminated composite plates', Composite structures; (1993), No.24(2): PP.(99 – 106).
- [37] Narita Y. Fukushi K., 'Analysis program for generally laminated rectangular plates based on classical plate theory', Trans. J. SME, (A); (1996), PP. (2621 – 2627).
- [38] Ashton J.E., Whitney J.M., 'theory of laminated plates', Stamford: Technomic publishing co., Inc.; (1970).
- [39] Jones R.M., 'Mechanics of composite materials', Washington: Scripta Book Co.; (1975).
- [40] Turvey G.J., Marshall I.H., 'Buckling and post buckling of composite plates', London: Chapman and Hall; (1995).
- [41] Singer J., Arbocz J., Weller T., 'Buckling experiments: Experimental methods in buckling of thin walled structures', vol.1, New York: John Willey and sons ;(1998).
- [42] Singer J., Arbocz J., Wetter T., 'buckling experiments: Experimental methods in buckling of thin walled structures: shells, Built up structures, composites and additional topics', vol.2. , New York: John Willey and sons; (2002).
- [43] Reddy J.N., second edition, 'Mechanics of laminated composite plates and shells', Boca Raton CRC press; (2004).
- [44] Leissa A.W., 'Buckling of laminated composite plates and shells panels', Air force Wright – Patterson aeronautical laboratories, final report ;(1985).

- [45] Herakovich C.T., Tarnopolskii Y.M.,' Hand book of composites structures and design', vol.2, Amsterdam: North Holland; (1989).
- [46] Berthelot J.M.,' Composite materials mechanical behavior and structural analyses', New York: Springer; (1999).
- [47] Whitney J.M.,' Structural analysis of laminated anisotropic plates', Lancaster, PA: Technomic Publishing; (1987).
- [48] Reddy J.N.,' Mechanics of laminated composite plates: Theory and Analyses', Boca Raton: CRC press; (1997).
- [49] Reddy J.N.,' Energy and variational methods in applied mechanics', New York: Wiley; (1984).
- [50] Reddy J.N., Phan N.S.,' Stability and natural vibration of isotropic, orthotropic and laminated plates according to a higher order shear deformable theory', Journal of sound and vibration; (1985), 9 (82):PP.(157 – 170).
- [51] Reddy J.N., Khdeir A.A.,' Buckling and vibration of laminated composite plates using various plate theories', AIAA; (1989), 27 (12):PP. (1808 – 1817).
- [52] Leissa A.W., Kang J.,' Exact solutions for vibration and buckling of an SS – C – SS – C rectangular plate loaded by linearly varying in – plane stresses', International Journal of mechanical sciences;(2002),44:PP.(1925 – 1945).
- [53] Iyengar N.G.,' Structural stability of columns and plates', Chichester, England: Ellis Horwood limited publishers; (1988).
- [54] Bao G., Jiang W., Roberts J.C.,' Analytic and finite element solutions for bending and buckling of orthotropic rectangular plates', International Journal of solids and structures ; (1997),34(14),PP.(1792 – 1821).
- [55] Robinson J.R.,' The buckling and bending of orthotropic sandwich panels with all edges- simply supported', Aero Q; (1955), 6(2):PP. (125).

- [56] Baharlou B., Leissa A.W.,' Vibration and buckling of generally laminated composite plates with arbitrary edge conditions', International Journal of mechanical sciences;(1987),29(8):PP.(545 – 555).
- [57] Dawe D.J., Wang S.,' Spline finite strip analysis of the buckling and vibration of rectangular composite laminated plates', International Journal of mechanical sciences; (1995),37(6):PP.(645 – 667).
- [58] Liu G.R., Chen X.L., Reddy J.N.,' Buckling of symmetrically laminated composite plates using the element free Galerkin method', International Journal of structural stability dynamics; (2002), 2(3):PP.(281 – 294).
- [59] Bert C.W., Malik M.,' Differential quadrature: A powerful new technique for analysis of composite structures', composite structures; (1997), 39(3– 4):PP. (179 – 189).
- [60] Huang Y.Q., Li Q.S.,' Bending and buckling analysis of anti – symmetric laminates using the least square differential quadrature method', Computer methods in applied mechanics and engineering, 193; (2004):PP. (3471 – 3492).
- [61] Kim Y.S., Hoa S.V.,' biaxial buckling behavior of composite rectangular plates', composite structures; (1995), 31(4):PP. (247 – 252).
- [62] Kantorovich L.V., Krylov I.V.,' approximate method of higher analyses', Groningen: P. Noordhoff Ltd; (1958).
- [63] Shufrin I., Rabinovitch O., Eisenberger M.,' Buckling of symmetrically laminated rectangular plates with general boundary conditions – A semi analytical approach', composite structures; (2007).
- [64] Kantorovich L.V., Krylov I.V.,' approximate method of higher analyses', New York: Interscience publishers Inc.; (1964).
- [65] Kerr A.D.,' An extended Kantorovich method for solution of Eigen value problem', International Journal of solids and structures; (1969), 5 (7):PP. (559– 572).

- [66] Eisenberger M., Alexandrov A.,' Buckling loads of variable thickness thin isotropic plates', thin – walled structures; (2003), 41(9):PP. (871 – 889).
- [67] Shufrin I., Eisenberger M.,' stability and vibration of shear deformable plates – first order and higher order analyses', International Journal of solid structures; (2005), 42(3 – 4):PP.(1225 – 1251).
- [68] Shufrin I., Eisenberger M.,' stability of variable thickness shear deformable plates – first order and higher order analyses', Thin – walled structures; (2005), 43(2): PP.(189 – 207).
- [69] Ungbhakorn V., singhatanadgid P.,' Buckling analysis of symmetrically laminated composite plates by extended Kantorovich method', Composite structures; (2006); 73(1):PP. (120 – 128).
- [70] Yuan S., Jin Y.,' Computation of elastic buckling loads of rectangular thin plates using the extended Kantorovich method', computer structures; (1998), 66(6):PP. (861 – 867).
- [71] March H.W., Smith C.B.,' Buckling loads of flat sandwich panels in compression', Forest products research laboratory report No.1525, Madison, WI; (1945).
- [72] Chang C.C., Ebcioğlu I.K., Haight C.H.,' General stability analysis of orthotropic sandwich panels for four different boundary conditions', Zeitschr Angew, Math. Mech.; (1962), 43:PP. (373 – 389).
- [73] Jiang W., Bao G., Roberts J.C.,' Finite element modeling of stiffened and unstiffened orthotropic plates', Computer and structures Journal; (1977), 63(1):PP. (105 – 117).
- [74] Smith C.S.,' Design of marine structures in composite materials', Amsterdam: Elsevier science publishers Ltd; (1990).
- [75] Zienkiewicz O.C.,' The finite element method', England: McGraw Hill; (1977).

- [76] Cook R.D., ' Concepts and applications of finite element analyses', New York: Wiley; (1981).
- [77] Yang H.T.Y., Saigal S., Masud A., Kapania R.K., ' A survey of recent shell element', International Journal for numerical methods in engineering, 47 (1–3); (2000):PP.(101 – 127).
- [78] Mindlin R.D., ' Influence of rotatory inertia and shear on flexural motions of isotropic elastic plates', Trans. ASME Journal of applied mechanics; (1951), 18:PP. (31 – 38).
- [79] Reddy J.N., ' A refined non – linear theory of laminated plates with transverse shear deformation', International Journal of solids and structures; (1984), 51:PP. (319 – 330).
- [80] Soladatos K.P., ' a transverse shear deformation theory for homogeneous monoclinic plates', Acta Mech.; (1992), 94:PP. (195 – 220).
- [81] Touratier M., ' An efficient standard plate theory', International Journal of engineering sciences; (1991), 29(8):PP. (901 – 916).
- [82] Di sciuva M., ' An improved shear deformation theory for moderately thick multi – layered anisotropic shells and plates', Journal of applied mechanics; (1987), 54: PP. (589 – 596).
- [83] Cho M., Parmerter R.R., ' Efficient higher – order composite plate theory for laminated composites', AIAA Journal; (1993), 31 – 7:PP. (1299 – 1306).
- [84] Karama M., Afaqk S., Mistou S., ' Mechanical behavior of laminated composite beam by the new multi – layered laminated composite structures model with transverse shear stress continuity', International Journal of solids and structures;(2003),40:PP.(1525 – 1546).
- [85] Jones R.M., ' Buckling and vibration of unsymmetrical laminated cross – ply rectangular plates', AIAA Journal; (1973), 12(11), PP. (1626 – 1632).

- [86] Narita Y., Leissa W.L., ' Buckling studies for simply supported symmetrically laminated rectangular plates', *Composite structures*; (1989), 12:PP. (113 – 132).
- [87] Lo K.H., Christensen R.M., Wu E.M., 'A high – order theory of plate deformation', part 1: homogeneous plates, *Journal of applied mechanics, Trans. ASME*; (1977), 44(4):PP. (663 – 668).
- [88] Lo K.H., Christensen R.M., Wu E.M., ' A high – order theory of plate deformation', part 2: Laminated plates, *Journal of applied mechanics*; (1977), 44 (4):PP. (669 – 676).
- [89] Reddy J.N., ' an evaluation of equivalent single layer and layer wise theories of composite laminates', *Composite structures*; (1993), 25: PP. (21– 35).
- [90] Reddy J.N., ' a simple higher – order theory for laminated composite plates', *Journal of applied mechanics*; (1984), 51:PP. (745 – 752).
- [91] Reddy J.N., ' A refined non – linear theory of plates with transverse shear deformation', *International Journal of solids and structures*; (1984), 20(9/10):PP. (881 – 896).
- [92] Reddy J.N., ' A general non – linear third – order theory of plates with transverse shear deformation', *Journal of Non – linear mechanics*; (1990), 25(6):PP. (677 – 686).
- [93] Librescu L., ' Electrostatics and kinetics of anisotropic and heterogeneous shell – type structures', Noordhoff: Leyden; (1975).
- [94] Schmidt R., ' A refined non – linear theory of plates with transverse shell deformation', *Journal of India mathematical society*; (1977), 27(1):PP. (23 – 38).
- [95] Krishna Murty A.V., ' higher order theory for vibration of thick plates', *AIAA Journal*; (1977), 15(12):PP. (1823 – 1824).
- [96] Levinson M., ' an accurate simple theory of the statics and dynamics of elastic plates', *Mechanical research community*; (1980), 7(6): PP. (343 – 350).
- [97] Seide P., ' an improved approximate theory for the bending theory of laminated plates', *Mechanics today*; (1980), 5:PP. (451 – 466).

- [98] Murthy M.V.V., 'an improved transverse shear deformation theory for laminated anisotropic plates', NASA technical paper, 1903; (1981), PP. (1 – 37).
- [99] Bhimaraddi A., Stevens L.K., ' A higher – order theory for free vibration of orthotropic, homogeneous, and laminated rectangular plates', Journal of applied mechanics; (1984), 51:PP.(195 – 198).
- [100] Mallikarjuna, Kant T., ' A critical review and some results of recently developed refined theories of fibers – reinforced laminated composites and sandwich plates', Composite structures ; (1993),23:PP.(293 – 312).
- [101] Kant T., Pandya,' A simple finite element formulation of higher – order theory for unsymmetrical laminated composite plates', Composite structures; (1988), 98, PP. (215 – 224).
- [102] Reddy J.N., ' An evaluation of equivalent single layer and layer wise theories of composite laminates', Composite structures; (1993), 25: PP. (21 – 35).
- [103] Reddy J.N., ' On refined theories of composite laminates', Meccanica; (1980), 25(4):PP. (230 – 238).
- [104] Noor A.K., Burton W.S., ' Assessment of computational models for multi – layered anisotropic plates', Composite structures; (1990), 14:PP. (233 – 265).
- [105] Bert C.W., 'A critical evaluation of new plate theories applied to laminated composites', Composite structures ; (1984),2:PP.(329 – 347).
- [106] Kant T., Kommineni J.R., ' geometrically non – linear analysis of symmetrically laminated composite and sandwich shells with higher – order theory and C^0 finite elements', composite structures; (1984), 27: PP. (403 – 418).
- [107] Reddy J.N., Robbins Jr D.H., ' Theories and computational models for composite laminates', Applied mechanics review, part 1; (1994), 47(6):PP. (147 – 165).

- [108] Khdeir A.A., 'Free vibration and buckling of unsymmetrical cross – ply laminated plates using a refined theory', *Journal of sound and vibration*; (1989), 128: PP. (377 – 395).
- [109] Hadian J., Nayfeh A.H., 'Free vibration and buckling of shear deformable cross – ply laminated plates using state – space concept', *Computer and structures*; (1993), 4: PP. (677 – 693).
- [110] Fares M.E., Zenkour A.M., 'Buckling and vibration of non – homogeneous composite cross – ply laminated plates with various plate theories', *Composite structures*; (1999), 44: PP. (279 – 287).
- [111] Matsunaga H., 'Vibration and stability of cross – ply laminated composite plates according to a global higher – order plate theory', *composite structures*; (2000), 48: PP. (231 – 244).
- [112] Gilat R., Williams T.O., Aboudi J., 'Buckling of composite plates by global – local plate theory', *Composite part B – Engineering*; (2001), 32: PP. (229 – 236).
- [113] Pagano N.J., 'Exact solution for rectangular bi – directional composite and sandwich plates', *Journal of composite materials*; (1970), 4: PP. (20 – 34).
- [114] Noor A.K., 'Stability of multi – layered composite plates', *Fiber science technology*; (1975), 8: PP. (81 – 89).
- [115] GU H., Chattopadhyay A., 'Three – dimensional elasticity solution for buckling of composite laminates', *Composite structures*; (2000), 50: PP. (29 – 35).
- [116] Reddy J.N., 'An evaluation of equivalent single layer and layer wise theories of composite laminates', *Composites structures*; (1993), 25: PP. (21 – 35).
- [117] Leissa A.W., 'Conditions for laminated plates to remain flat under in – plane loading', *Composite structures*; (1986), 6: PP. (261 – 270).
- [118] Qatu M.S., Leissa A.W., 'Buckling of transverse deflections of unsymmetrically laminated plates subjected to in – plane loads', *AIAA Journal*; (1993), 31(1): PP. (189 – 194).

- [119] Bazant Z.P., Gedolin L., 'Stability of structures', New York: Oxford University press; (1991).
- [120] Column research committee of Japan, 'Handbook of structural stability', Tokyo: Corona; (1971).
- [121] Gerard G., Becker H., 'Handbook of structural stability: part 1, Buckling of flat plates', Technical report, NASA TN 3781; (1957).
- [122] Leissa A.W., 'Vibration of plates', (Nasa Sp-169), Washington (DC): Office of technology utilization; (1969).
- [123] Cox H.L., Klein B., 'The buckling of isosceles triangular plates', Journal of Aeronautical science; (1955), 22:PP. (321 – 325).
- [124] Ramaiah G.K., 'Flexural vibrations and elastic stability of annular plates under uniform in – plane tensile forces along inner edge', Journal of sound and vibration ;(1980), 72:PP. (11 – 23).
- [125] Harik I.E., 'Stability of annular sector plates with clamped radial edges', Journal of applied mechanics, ASME; (1985).
- [126] Su G.H., Xiang y., 'A non – discrete approach for the analysis of plates with multiple sub domains', Engineering structures, 24; (2002):PP. (563 – 575).
- [127] Naruoka M., 'Bibliography on theory of plates', Gihodo, Tokyo ;(1976).
- [128] Winterstetter Th. A. and Schmidt H., 'Stability of circular cylindrical steel shells under combined loading', Thin – walled structures; (2002), 40:PP. (893 –909).
- [129] Pircher M., and Bridge R., ' The influence of circumferential weld – induced imperfections on the buckling of silos and tanks', Journal of constructional steel research; (2001), 57 (5) : PP.(569 – 580).
- [130] Deml M., and Wunderlich W., ' Direct evaluation of the worst imperfection shape in shell buckling', Computer methods in applied mechanics and engineering; (1997), 149 [1 – 4]: PP. (201 – 222).

- [131] Arbocz J., and Starnes J.H., 'Future directions and challenges in shell stability analysis', *Thin – walled structures*; (2002), 40: PP. (729 – 754).
- [132] Arbocz J., 'The effect of imperfect boundary conditions on the collapse behavior of anisotropic shells', *International Journal of solids and structures*; (2000), 37: PP. (6891 – 6915).
- [133] Huhne C., Zimmermann R., Rolfes R., and Geier B., 'loading imperfections – experiments and Computations', *Euromech Colloquium 424* ;(2001), the Netherlands.
- [134] Geier B., Klein H., and Zimmermann R., 'Buckling tests with axially Compressed unstiffened cylindrical shells made from CFRP', proceedings, *International Colloquium on buckling of shell structures on land, in the sea , and in the air*, Elsevier applied sciences; (1991), London and New York: PP.(498– 507).
- [135] Geier B., Klein H., and Zimmermann,' Experiments on buckling of CFRP Cylindrical shells under non – uniform axial load', proceedings of international conference on Composites engineering; (1994).
- [136] Albus J., Gomez – Garcia J., and oery H., 'Control of assembly induced stresses and deformations due to the waviness of the interface flanges of the ESC – An upper stage', 52nd International astronautical congress; (2001), Toulouse, France.
- [137] Zimmermann R., 'Buckling research for imperfection tolerant fiber composite structures', proceeding of the conference on spacecraft structures, material and mechanical testing, Nordwijk, The Netherlands: (1996).
- [138] Meyer – Piening H.R., Farshad M., Geier B., and Zimmermann, 'Buckling loads of CFRP Composite cylinders under combined axial and torsion loading – experiments and computations', *Composite structures*; (2001), 52:PP. (427 – 435).
- [139] CMH – 17 (*Composite Material Handbook – 17*), Material science corporation; (2010).
- [140] Guo S.J., 'Stress concentration and buckling behaviour of shear loaded composite panels with reinforced cutouts', *Composite structures* ;(2007):PP. (1– 9).

- [141] Remmers J.J.C., and de Borst R., ' Delamination buckling of fiber – metal laminates', Composite science and technology; (2001):PP. (2207 – 2213).
- [142] Vit obdrzalek, and Jan Vrbka, ' Buckling and post buckling of a large delaminated plate subjected to shear loading', Engineering mechanics, vol. 16; (2009), No.4: PP. (297 – 312).
- [143] Vit obdrzalek, and Jan Vrbka, ' On buckling of a plate with multiple delaminations', Engineering mechanics, vol.17; (2010), No. 1:PP. (37 – 47).
- [144] Keiichi Nemoto, Hirakazu Kasuya, Hisao Kikugawa, and Takashi Asaka, ' post buckling behaviour of composite laminated plates with initial imperfections under biaxial compression', Materials transactions, vol.50,No.2;(2009):PP.(299 – 304).
- [145] Takao Y., Taya M., and Chou T.W., ' Stress field due to cylindrical inclusion with constant axial eingenstrain in an infinite elastic body', Journal of applied mechanics; (1981), 48(4):PP. (853 – 858).
- [146] Lakshminarayana H.V., and Murthy M.V.V., ' On stresses around an arbitrarily oriented Crack in cylindrical shell', International Journal of fracture; (1976), 12(4):PP. (547 – 566).
- [147] Twee J., and Rooke D.P, ' The stress intensity factor for a crack at the edge of a loaded hole', International Journal of solids and structures; (1979), 15:PP. (899 – 906).
- [148] Dyshel M.S., ' Fracture of plates with cracks under tension after loss of stability', Journal of applied mathematics and mechanics (PMM); (1981), 17(4):PP. (77 – 83).
- [149] Erdogan F., Ratwani M., and Yuceoglu U., ' On the effect of orthotropy in cracked cylindrical plates', International Journal of fracture; (1974), 10 (4):PP. (369 – 374).
- [150] Krenk S., ' Influence of transverse shear on an axial crack in a cylindrical shell', International Journal of fracture; (1978), 14(2): PP. (123 – 142).

- [151] Delale F., and Erdogan F., 'Effect of transverse shear and material orthotropy in a cracked spherical cap', *International Journal of solids and structures*; (1979), 15:PP. (907 – 926).
- [152] Lakshminarayana H.V., and Murthy M.V.V., 'On a finite element model for the analysis of through cracks in laminated anisotropic cylindrical shells', *Engineering fracture mechanics*; (1981), 14(4):PP. (697 – 712).
- [153] Theocaris P.S., and Milios J., 'Crack – arrest at a bimaterial interface', *International Journal of solids and structures*; (1981), 17:PP. (217 – 230).
- [154] Rogers T.G., 'Crack extension and energy release rates in finitely deformed sheet reinforced with inextensible fibers', *International Journal of solids and structures*; (1982), 18:PP.(705 – 721).
- [155] Kachanov L.M., 'Separation failure of composite materials', *polymer mechanics*; (1976), 6 (12):PP. (812 – 815).
- [156] Williams J.G., and et al., 'Recent developments in the design, testing and impact damage – tolerance of stiffened composite plates', *Nasa TM 80077*; (1979), April.
- [157] Wilkins D.J, and et al., 'characterizing delamination growth in graphite – epoxy', *Damage in composite materials*; (1982): PP. (168 – 183).
- [158] Wang S.S., 'Edge delamination in angle – ply composite laminates', *AIAA Journal*; (1984), 22(2):PP. (256 – 264).
- [159] Scott W. Beckwith, 'Manufacturing defects in composite structures', *Sample Journal*, volume 48, No.5; September/October (2012).
- [160] M. Vable, 'Stability of columns', *Mechanics of materials*; (2014): chapter eleven, PP. (496 – 528).
- [161] CPNI EBP, 'Influence of delamination of laminated glass on its blast performance', July (2013).

- [162] Mahmoud Yassin Osman and Osama Mohammed Elmardi Suleiman, 'Buckling analysis of thin laminated composite plates using finite element method', International Journal of Engineering Research and Advanced Technology, (IJERAT), Volume 3, Issue 3; March (2017), PP. (1 – 18).
- [163] Mahmoud Yassin Osman and Osama Mohammed Elmardi Suleiman, 'Large deflection of composite beams', International Journal of Engineering Research and Advanced Technology (IJERAT), Volume 3, Issue 3; (2017), PP. (26 – 39).
- [164] Mahmoud Yassin Osman and Osama Mohammed Elmardi Suleiman, 'Free vibration of laminated plates', International Journal of Engineering Research and Advanced Technology (IJERAT), Volume 3, Issue 4; (2017), PP. (31 – 47).
- [165] Mahmoud Yassin Osman and Osama Mohammed Elmardi Suleiman, 'Free vibration analysis of laminated composite beams using finite element method', International Journal of Engineering Research and Advanced Technology, (IJERAT), Volume 3, Issue 2; (2017), PP. (5 – 22).

APPENDICES

Appendix (A)

The transformed material properties are:

$$C_{11} = C'_{11}\cos^4\theta + C'_{22}\sin^4\theta + 2(C'_{12} + 2C'_{66})\sin^2\theta\cos^2\theta$$

$$C_{12} = (C'_{11} + C'_{22} - 4C'_{66})\sin^2\theta\cos^2\theta + C'_{12}(\cos^4\theta + \sin^4\theta)$$

$$C_{22} = C'_{11}\sin^4\theta + C'_{22}\cos^4\theta + 2(C'_{12} + 2C'_{66})\sin^2\theta\cos^2\theta$$

$$C_{16} = (C'_{11} - C'_{12} - 2C'_{66})\cos^3\theta\sin\theta - (C'_{22} - C'_{12} - 2C'_{66})\sin^3\theta\cos\theta$$

$$C_{26} = (C'_{11} - C'_{12} - 2C'_{66})\cos\theta\sin^3\theta - (C'_{22} - C'_{12} - 2C'_{66})\sin\theta\cos^3\theta$$

$$C_{66} = (C'_{11} + C'_{22} - 2C'_{12} - 2C'_{66})\sin^2\theta\cos^2\theta + C'_{66}(\sin^4\theta + \cos^4\theta)$$

where $C'_{11} = \frac{E_1}{1 - \nu_{12}\nu_{21}}$, $C'_{22} = \frac{E_2}{1 - \nu_{12}\nu_{21}}$, $C'_{12} = \frac{\nu_{12}E_2}{1 - \nu_{12}\nu_{21}}$, $C'_{16} = G_{12}$

Appendix (B)

$$a_{i,j}/8$$

$N_i \backslash i$	$i, 1$	$i, 2$	$i, 3$	$i, 4$	$i, 5$	$i, 6$	$i, 7$	$i, 8$	$i, 9$	$i, 10$	$i, 11$	$i, 12$
N_1	2	-3	3	0	-4	0	1	0	0	-1	1	1
N_2	1	-1	1	-1	-1	0	1	-1	0	0	1	0
N_3	-1	1	-1	0	1	1	0	0	-1	1	0	-1
N_4	2	-3	-3	0	4	0	1	0	0	1	-1	-1
N_5	1	-1	-1	-1	1	0	1	1	0	0	-1	0
N_6	1	-1	-1	0	1	-1	0	0	1	1	0	-1
N_7	2	3	3	0	4	0	-1	0	0	-1	-1	-1
N_8	-1	-1	-1	1	-1	0	1	1	0	0	1	0
N_9	-1	-1	-1	0	-1	1	0	0	1	1	0	1
N_{10}	2	3	-3	0	-4	0	-1	0	0	1	1	1
N_{11}	-1	-1	1	1	1	0	1	-1	0	0	-1	0
N_{12}	1	1	-1	0	-1	-1	0	0	-1	1	0	1

Appendix (C)

The integrals in equations (13) and (14) are given in nondimensional form as follows (limits of integration $r, s = -1$ to 1):

$$\iint \frac{\partial^2 N_i}{\partial x^2} \frac{\partial^2 N_j}{\partial x^2} dx dy = \frac{4h_y}{h_x^3} \iint \frac{\partial^2 N_i}{\partial r^2} \frac{\partial^2 N_j}{\partial r^2} dr ds$$

$$= \frac{4n^3}{mR} (16a_{i,4} a_{j,4} + 48a_{i,7}a_{j,7} + 16a_{i,8}a_{j,8}/3 + 16a_{i,11}a_{j,11})$$

$$\iint \frac{\partial^2 N_i}{\partial y^2} \frac{\partial^2 N_j}{\partial y^2} dx dy = \frac{4h_x}{h_y^3} \iint \frac{\partial^2 N_i}{\partial s^2} \frac{\partial^2 N_j}{\partial s^2} dr ds$$

$$= \frac{4m^3 R^3}{n} (16a_{i,6} a_{j,6} + 16a_{i,9}a_{j,9}/3 + 48a_{i,10}a_{j,10} + 16a_{i,12}a_{j,12})$$

$$\iint \frac{\partial^2 N_i}{\partial x^2} \frac{\partial^2 N_j}{\partial y^2} dx dy = \frac{4}{h_y h_x} \iint \frac{\partial^2 N_i}{\partial r^2} \frac{\partial^2 N_j}{\partial s^2} dr ds$$

$$= 4mnR(16a_{i,4} a_{j,6} + 16a_{i,7}a_{j,9} + 16a_{i,8}a_{j,10} + 16a_{i,11}a_{j,12})$$

$$\iint \frac{\partial^2 N_i}{\partial y^2} \frac{\partial^2 N_j}{\partial x^2} dx dy = \frac{4}{h_y h_x} \iint \frac{\partial^2 N_i}{\partial s^2} \frac{\partial^2 N_j}{\partial r^2} dr ds$$

$$= 4mnR(16a_{i,6} a_{j,4} + 16a_{i,9}a_{j,7} + 16a_{i,10}a_{j,8} + 16a_{i,12}a_{j,11})$$

$$\iint \frac{\partial^2 N_i}{\partial x \partial y} \frac{\partial^2 N_j}{\partial x \partial y} dx dy = \frac{4}{h_y h_x} \iint \frac{\partial^2 N_i}{\partial r \partial s} \frac{\partial^2 N_j}{\partial r \partial s} dr ds =$$

$$4mnR[4a_{i,5} a_{j,5} + 4(3a_{i,5}a_{j,11} + 4a_{i,8}a_{j,8})/3$$

$$+ 4(3a_{i,5} a_{j,12} + 4a_{i,9}a_{j,9})/3 + 4(a_{i,11} a_{j,12} + a_{i,12}a_{j,11}) + 36a_{i,12}a_{j,12}/5]$$

$$\iint \frac{\partial N_i}{\partial x} \frac{\partial N_j}{\partial x} dx dy = \frac{h_y}{h_x} \iint \frac{\partial N_i}{\partial r} \frac{\partial N_j}{\partial r} dr ds$$

$$= \frac{n}{mR} [4a_{i,2} a_{j,2} + 4(3a_{i,2}a_{j,7} + 4a_{i,4}a_{j,4} + 3a_{i,7}a_{j,2})/3$$

$$+ 4(a_{i,2}a_{j,9} + a_{i,5}a_{j,5} + a_{i,9}a_{j,2})/3 + 4(3a_{i,5} a_{j,11} + 3a_{i,7}a_{j,9} + 4a_{i,8}a_{j,8}$$

$$+ 3a_{i,9}a_{j,7} + 3a_{i,11}a_{j,5})/9 + 4(a_{i,5}a_{j,12} + a_{i,9}a_{j,9} + a_{i,12}a_{j,5})/5$$

$$+ 36a_{i,7}a_{j,7}/5 + 12a_{i,11}a_{j,11}/5 + 4(a_{i,11}a_{j,12} + a_{i,12}a_{j,11})/5 + 4a_{i,12}a_{j,12}/7]$$

$$\iint \frac{\partial N_i}{\partial y} \frac{\partial N_j}{\partial y} dx dy = \frac{h_x}{h_y} \iint \frac{\partial N_i}{\partial s} \frac{\partial N_j}{\partial s} dr ds$$

$$= \frac{mR}{n} [4a_{i,3} a_{j,3} + 4(a_{i,3}a_{j,8} + a_{i,5}a_{j,5} + a_{i,8}a_{j,3})/3$$

$$+ 4(3a_{i,3}a_{j,10} + 4a_{i,6}a_{j,6} + 3a_{i,10}a_{j,3})/3 + 4(3a_{i,5} a_{j,11} + a_{i,8}a_{j,8} + a_{i,11}a_{j,5})/5$$

$$+ 4(3a_{i,5}a_{j,12} + 3a_{i,8}a_{j,10} + 4a_{i,9}a_{j,9} + 3a_{i,10}a_{j,8} + 3a_{i,12}a_{j,5})/9$$

$$+ 36a_{i,10}a_{j,10}/5 + 4(a_{i,11}a_{j,12} + a_{i,12}a_{j,11})/5 + 12a_{i,12}a_{j,12}/5 + 4a_{i,11}a_{j,11}/7]$$

$$\iint \frac{\partial N_i}{\partial x} \frac{\partial N_j}{\partial y} dx dy = \iint \frac{\partial N_i}{\partial r} \frac{\partial N_j}{\partial s} dr ds$$

$$= 4a_{i,2}a_{j,3} + 4(a_{i,2}a_{j,8} + 2a_{i,4}a_{j,5} + 3a_{i,7} a_{j,8})/3 + 4(3 a_{i,2}a_{j,10} + 2a_{i,5}a_{j,6}$$

$$+a_{i,9}a_{j,3})/3 + 4(2a_{i,4}a_{j,11} + 3a_{i,7}a_{j,8})/5 + 4(6a_{i,4}a_{j,12} + 9a_{i,7}a_{j,10} \\ + 4a_{i,8}a_{j,9} + a_{i,9}a_{j,8} + 6a_{i,11}a_{j,6})/9 + 4(3a_{i,9}a_{j,10} + 2a_{i,12}a_{j,6})/5$$

$$\iint \frac{\partial N_i}{\partial y} \frac{\partial N_j}{\partial x} dx dy = \iint \frac{\partial N_i}{\partial s} \frac{\partial N_j}{\partial r} dr ds \\ = 4a_{i,3}a_{j,2} + 4(3a_{i,3}a_{j,7} + 2a_{i,5}a_{j,4} + a_{i,8}a_{j,2})/3 + 4(a_{i,3}a_{j,9} + 2a_{i,6}a_{j,5} \\ + 3a_{i,10}a_{j,2})/3 + 4(6a_{i,6}a_{j,11} + a_{i,8}a_{j,9} + 4a_{i,9}a_{j,8} + 9a_{i,10}a_{j,7} + 6a_{i,2}a_{j,4})/9 \\ + 4(2a_{i,6}a_{j,12} + 3a_{i,10}a_{j,9})/5 + 4(3a_{i,8}a_{j,7} + 2a_{i,11}a_{j,4})/5$$

$$\iint \frac{\partial^2 N_i}{\partial x^2} \frac{\partial^2 N_j}{\partial x \partial y} dx dy = \frac{4}{h_x^2} \iint \frac{\partial^2 N_i}{\partial r^2} \frac{\partial^2 N_j}{\partial r \partial s} dr ds \\ = 4n^2 [8a_{i,4}(a_{j,5} + a_{j,11} + a_{j,12}) + 16(a_{i,7}a_{j,8} + a_{i,8}a_{j,9}/3)]$$

$$\iint \frac{\partial^2 N_i}{\partial x \partial y} \frac{\partial^2 N_j}{\partial x^2} dx dy = \frac{4}{h_x^2} \iint \frac{\partial^2 N_i}{\partial r \partial s} \frac{\partial^2 N_j}{\partial r^2} dr ds \\ = 4n^2 [8a_{j,4}(a_{i,5} + a_{i,11} + a_{i,12}) + 16a_{i,8}a_{j,7} + 16a_{i,9}a_{j,8}/3]$$

$$\iint \frac{\partial^2 N_i}{\partial y^2} \frac{\partial^2 N_j}{\partial x \partial y} dx dy = \frac{4}{h_y^2} \iint \frac{\partial^2 N_i}{\partial s^2} \frac{\partial^2 N_j}{\partial r \partial s} dr ds \\ = 4m^2 R^2 [8a_{i,6}(a_{j,5} + a_{j,11} + a_{j,12}) + 16a_{i,10}a_{j,9} + 16a_{i,9}a_{j,8}/3]$$

$$\iint \frac{\partial^2 N_i}{\partial x \partial y} \frac{\partial^2 N_j}{\partial y^2} dx dy = \frac{4}{h_y^2} \iint \frac{\partial^2 N_i}{\partial r \partial s} \frac{\partial^2 N_j}{\partial s^2} dr ds \\ = 4m^2 R^2 [8a_{j,6}(a_{i,5} + a_{i,11} + a_{i,12}) + 16a_{i,9}a_{j,10} + 16a_{i,8}a_{j,9}/3]$$

In the above expressions $h_x = \frac{a}{n}$, $h_y = \frac{b}{m}$ where a and b are the dimensions of the plate in the x – and y – directions respectively. n and m are the number of elements in the x – and y – directions respectively. Note that $dx = \frac{h_x}{2} dr$ and $dy = \frac{h_y}{2} ds$ where r and s are the normalized coordinates, and $R = a/b$.

AUTHOR



Osama Mohammed Elmardi Suleiman Khayal was born in Atbara, Sudan in 1966. He received his diploma degree in mechanical engineering from Mechanical Engineering College, Atbara, Sudan in 1990. He also received a bachelor degree in mechanical engineering from Sudan University of Science and Technology – Faculty of Engineering in 1998, and a master degree in solid mechanics from Nile Valley University (Atbara, Sudan) in 2003. He contributed in teaching some subjects in other universities such as Red Sea University (Port Sudan, Sudan), Kordofan University (Obayied, Sudan), Sudan University of Science and Technology (Khartoum, Sudan) and Blue Nile University (Damazin, Sudan). In addition, he supervised more than hundred and fifty under graduate studies in diploma and B.Sc. levels and about fifteen master theses. He is currently an assistant professor in department of mechanical engineering, Faculty of Engineering and Technology, Nile Valley University. His research interest and favorite subjects include structural mechanics, applied mechanics, control engineering and instrumentation, computer aided design, design of mechanical elements, fluid mechanics and dynamics, heat and mass transfer and hydraulic machinery. He also works as a consultant and technical manager of Al – Kamali workshops group for small industries in Atbara old and new industrial areas.