

المقدمة

- تعتبر مصر من أهم الدول السياحية على المستوى العالمي وأشهرها لأنها تتمتع بالآثار والشواطئ ذات المناظر والعناصر الطبيعية مثل العيون الطبيعية و الرمال الناعمة التي تستخدم في الأستشفاء.
- وعلي ضوء هذه العناصر يتم إنشاء المشروعات السياحية الترفيهية العلاجية والتي يعتبر مشروعنا أحد هذه المشاريع في منطقة العين الساخنة علي ساحل البحر الأحمر .
- ويهدف هذا المشروع إلى الترفيه والسياحة من ناحية المستخدمين أما من الناحية المعمارية يهدف إلى التلائم مع الموقع و فاعلية علاقات المشروع وعناصره.



***An Analysed example
of Hotel & SPA***

HAMMAMAT PHARAOUN

HOTEL & SPA RESORT

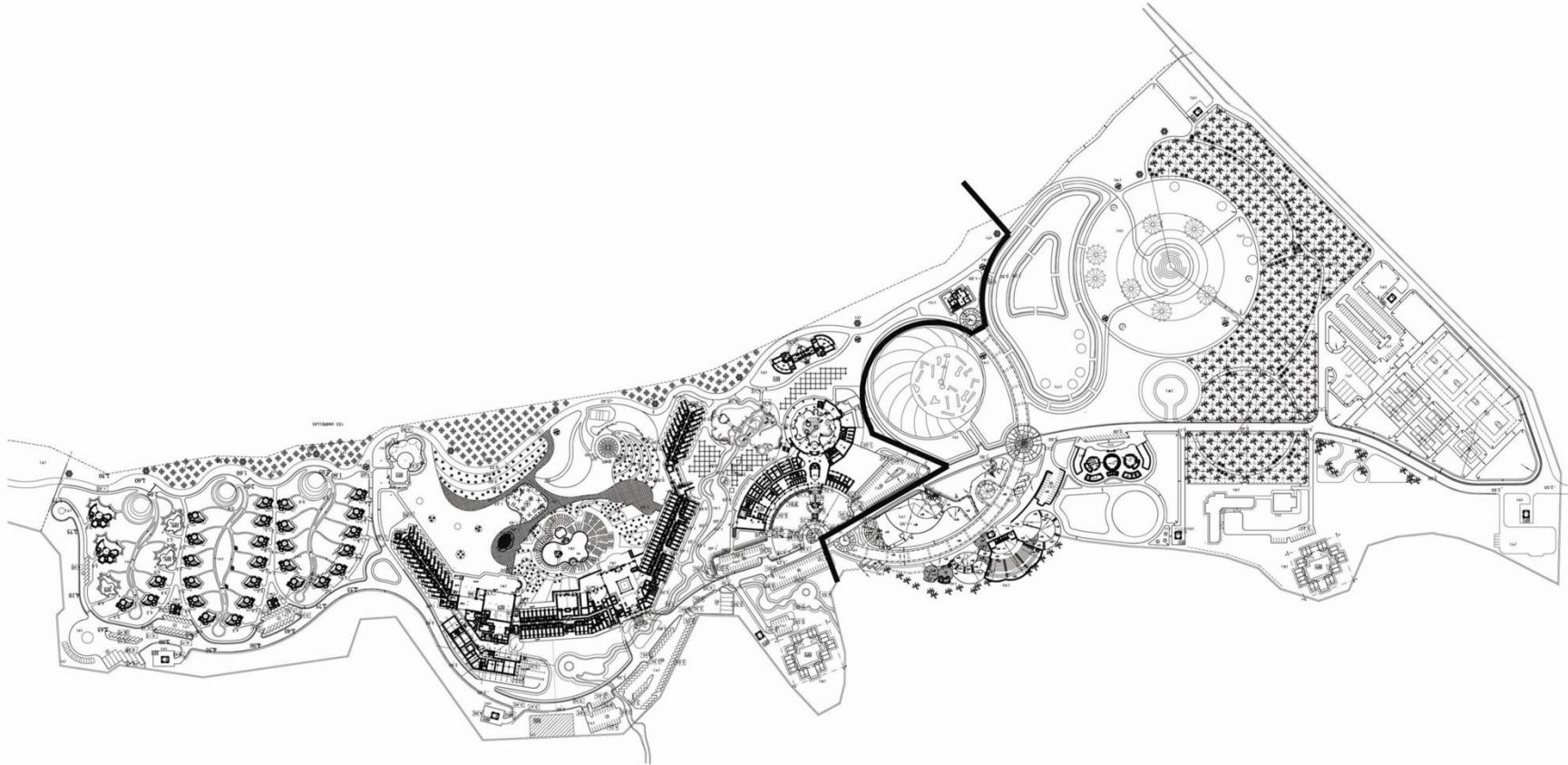

Climatic Study

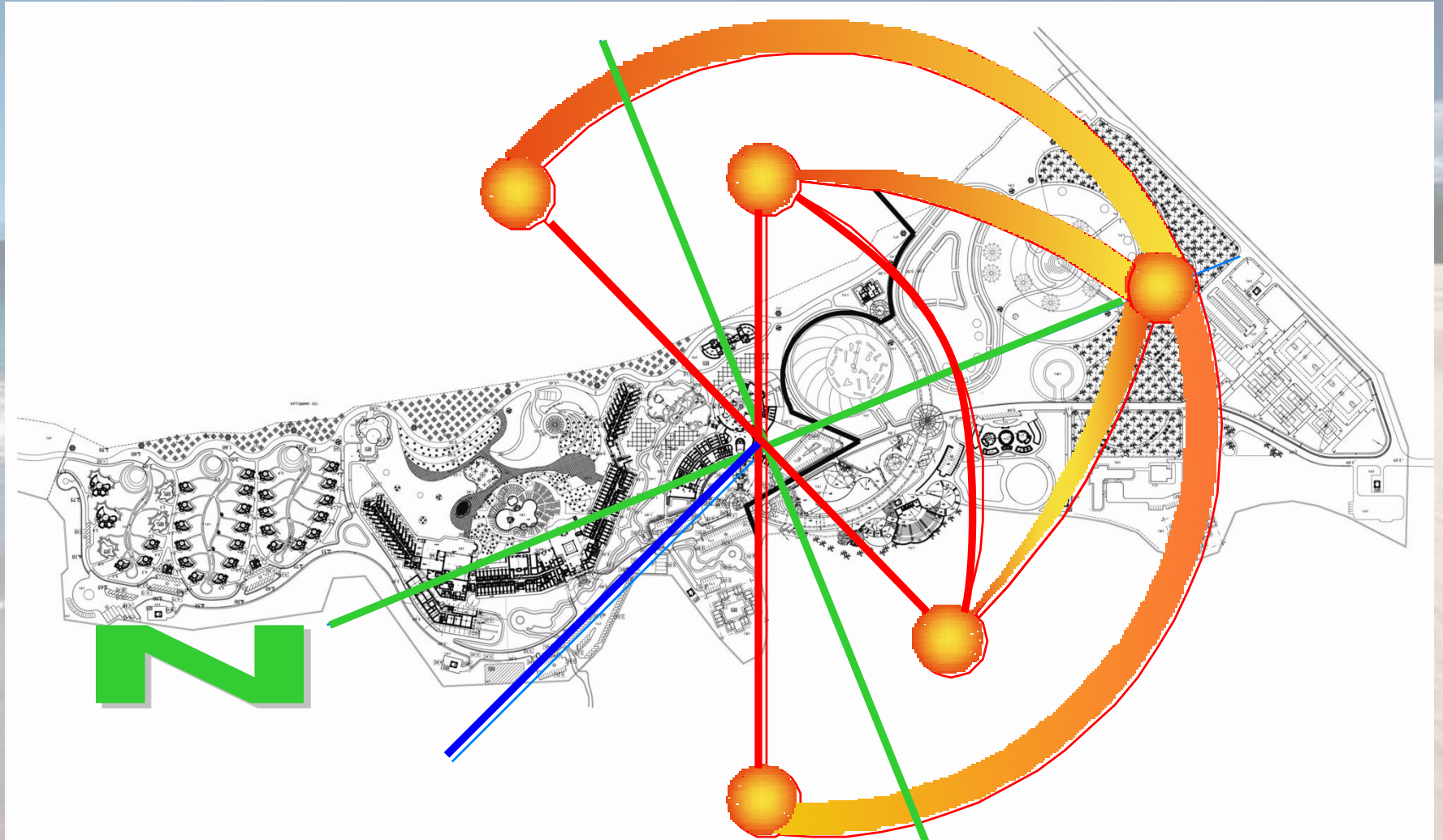

Site Use



An aerial photograph of a coastal landscape. The foreground is dominated by a large, sandy dune with distinct, wavy ripples in the sand. To the left, the ocean meets the shore with gentle waves and white foam. The beach extends into the distance, where the sand meets a line of green vegetation under a clear blue sky with scattered white clouds.

Layout analysis

Open areas



- | | |
|-------------------------|--------------------------|
| ● مطبخ لسطحى | ● حمامات |
| ● Parking | ● خط سير الزائرين |
| ● ملاعب Tennis و Basket | ● المكتبة |
| ● ساحل بحري | ● شاليهات لإعلاء المشورة |
| ● قرية بدوية | ● بيوت مائة طينية للجراج |
| ● مناطق سفاري | ● مطبخ مطبخ طازج للبيوت |
| ● مناطق حفرة | ● ملاعب جولف |
| ● مناطق سكنة العالميين | ● سارات حركة الترميم |



المناطق المفتوحة للعلاج الطبيعي :

نجاح المصمم فى عمل خصوصية تامة للموقع و ذلك بوضعها فى نهاية ارض المشروع
نجاح فى توزيع الشاليهات بطريقة جيدة لتوفير الخصوصية اللازمة ,
توفير view جيد
من محددات الموقع وجود العيون العلاجية فى هذا المكان من الموقع .
بالرغم من توفير الخصوصية نجاح فى ايجاد علاقة قوية بالفندق
من نقاط ضعف المشروع وجود ال S.P.A فى منطقة بعيدة عن هذه
المنطقة .

S.P.A Area



- | | |
|---|--|
| ● مطعم لسطحى
● Parking
● ملاعب Tennis و Basket
● شاطئ لبحر
● قرية بدوية
● مناطق سفاري
● مناطق حضرية
● مناطق سكنة العالميين | ● حمامات
● خط سير الزائرين
● القصور
● شاليهات لإصلاح المشي
● بيوت مائة طيحية للجراج
● مطبخ مطبخ طازان الهيلووتر
● ملاعب جولف
● مسارات حركة الخيول |
|---|--|



: S.P.A

- وضع ال SPA فى مقدمة المبانى وذلك ليكون قريب من المدخل الرئيسى لسهولة الاستخدام المباشر (Day use) .
- قريب من الفندق و ذلك لوجود مرافقين او للاستخدام اليومى للنزلاء الغير مرضى
- من نقاط الضعف وجود الspa بعيد عن مناطق العلاج المكشوفة .

Beach restaurant



- مطاعم لسطى
- مطاعم
- Tennis و Basket ملاعب
- ملاعب
- شاطئ لبحر
- قرية بدوية
- مناطق سفاري
- مناطق حفرة اذ
- مناطق سكنة العالميه
- حمامات
- خط سير الزائرين
- القصور
- شاليهات اطلاق البكسونه
- بيوت مراه طبيعيت للجرايح
- مطبخ و عرط حاران الهيلو لوتير
- ملاعب جولف
- مسارات حركة الخدمه

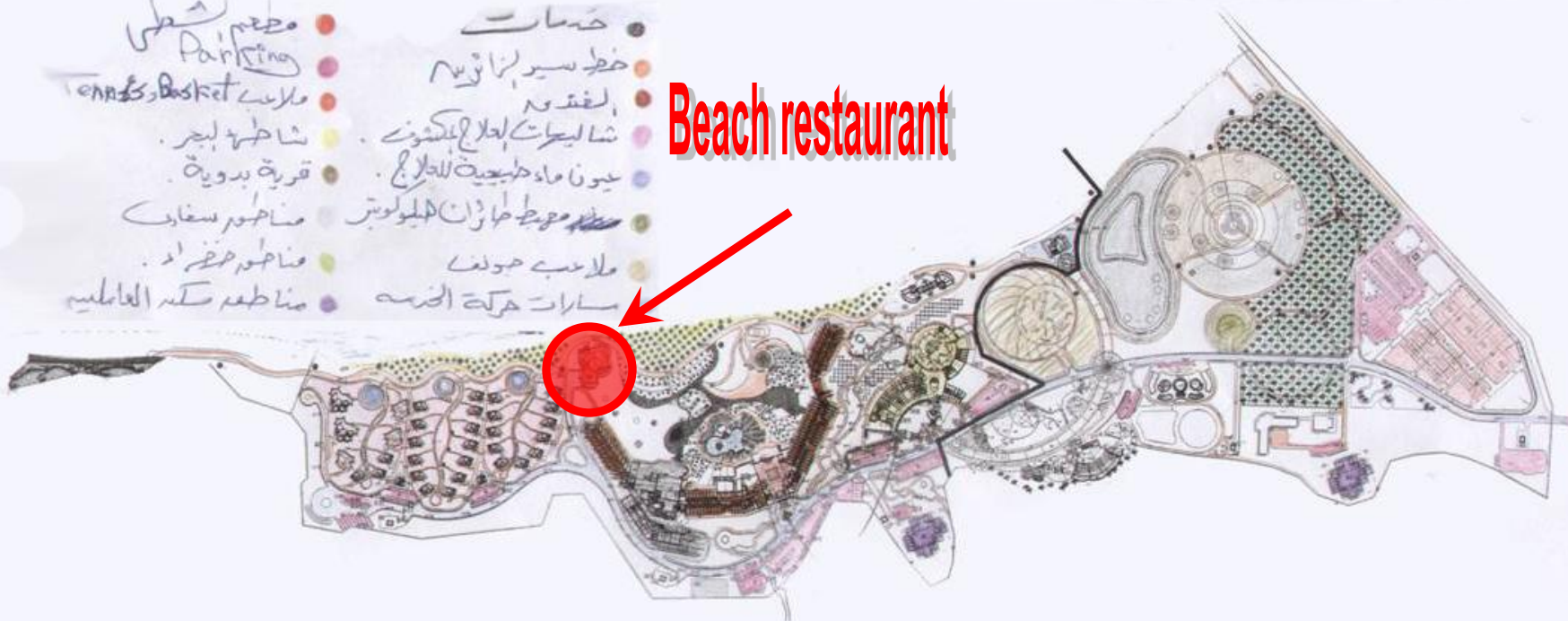

المطعم :

- فى منطقة متوسطة بين الفندق و منطقة العلاج المكشوفة
- له مطل جميل على البحر (good view)
- يتصل بممر خدمة خلفى خاص لخدمة المطبخ

Landing area



مهبط طائرات هليوكوبتر :

قريب من المدخل الرئيسي

على الطريق الرئيسي للمشروع

بعيد عن المناطق الهامه التي تحتاج للهدوء

Housing staff



مناطق سكن العاملين :

- فصلهم عن المشروع يعتبر ميزة
- فى منطقة غير مطلة على البحر لعدم الحاجة الى ذلك.
- مقسوم الى مبنيين وذلك ليكون اقرب ما يمكن لمناطق العمل

المناطق الترفيهية و الملاعب :

- وضع الملاعب فى منطقة غير مطلة على البحر لعدم الحاجة الى ذلك .
- منطقة الالعاب المائية قريبة من البحر كما انها قريبة من الفندق و SPA
- نجح فى عمل Zoon ترفيهى متكامل ولكنه فشل فى جعله قريب من الاماكن الرئيسية فى المشروع
- فصل الملاعب عن باقى المشروع بغابات النخيل يعتبر من العيوب فى المشروع حيث انه كان من الممكن عمل غابات النخيل عند المدخل لتأهيب الزائر للدخول و للفصل بين جو الطريق الصحراوى وما بين داخل المشروع .
- فصل الملاعب الى قسمين ملاعب الجولف جزء و باقى الملاعب جزء اخر .

An aerial photograph of a wide, sandy beach. The ocean waves are breaking on the left side, creating white foam. The sand is light-colored and shows some ripples. The sky is a clear, pale blue with a few wispy clouds on the right side. In the background, there are some green hills or mountains.

1- The SPA area

S.P.A Area

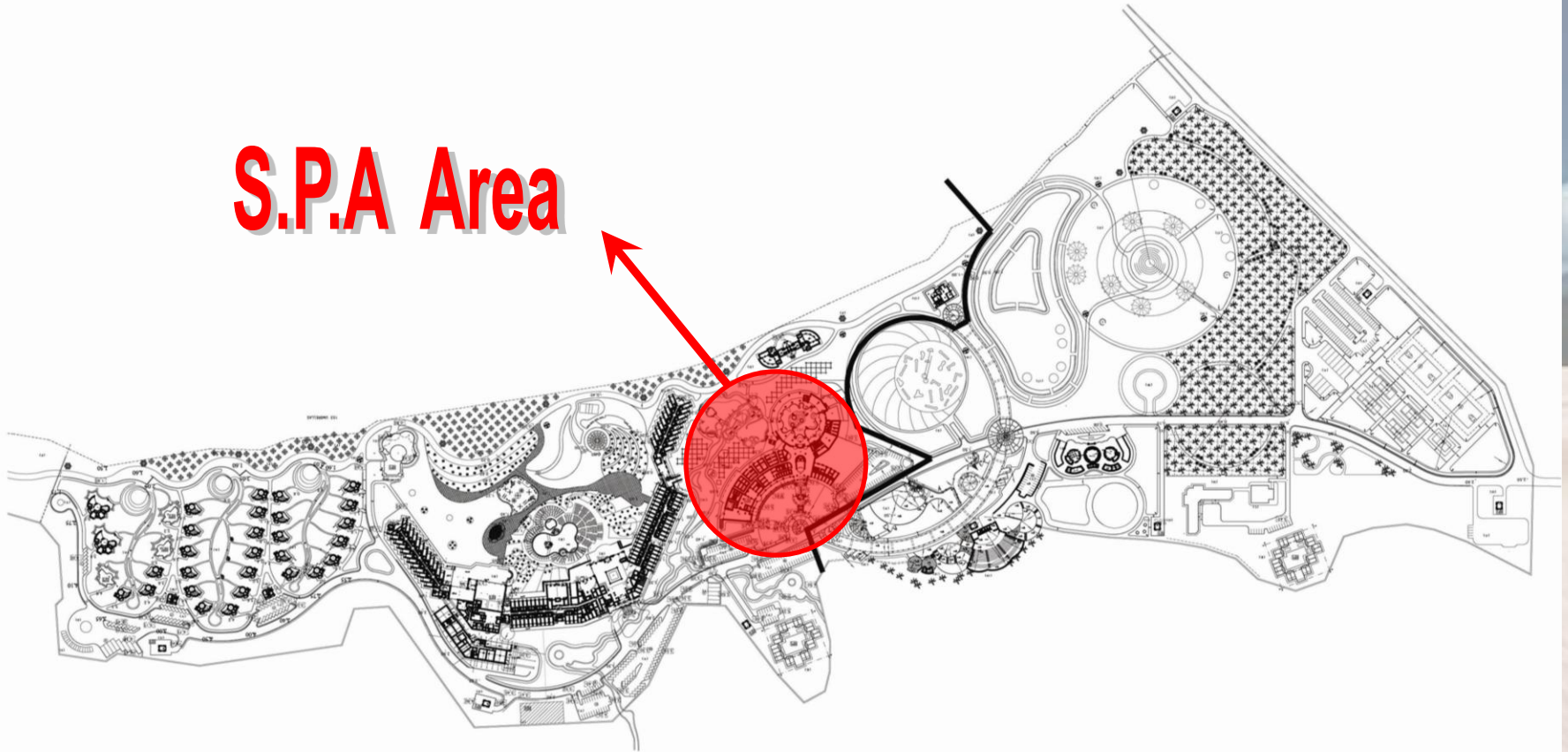

- De-fected area ●
- Indoor Relaxation area ●
- Services ●
- Outdoor Relaxation area ●
- Coast area ●
- Dry area ●
- Ladies area ●
- Gentlemen area ●
- Shoe may be worn area ●
- Kiosks beyond this point ●

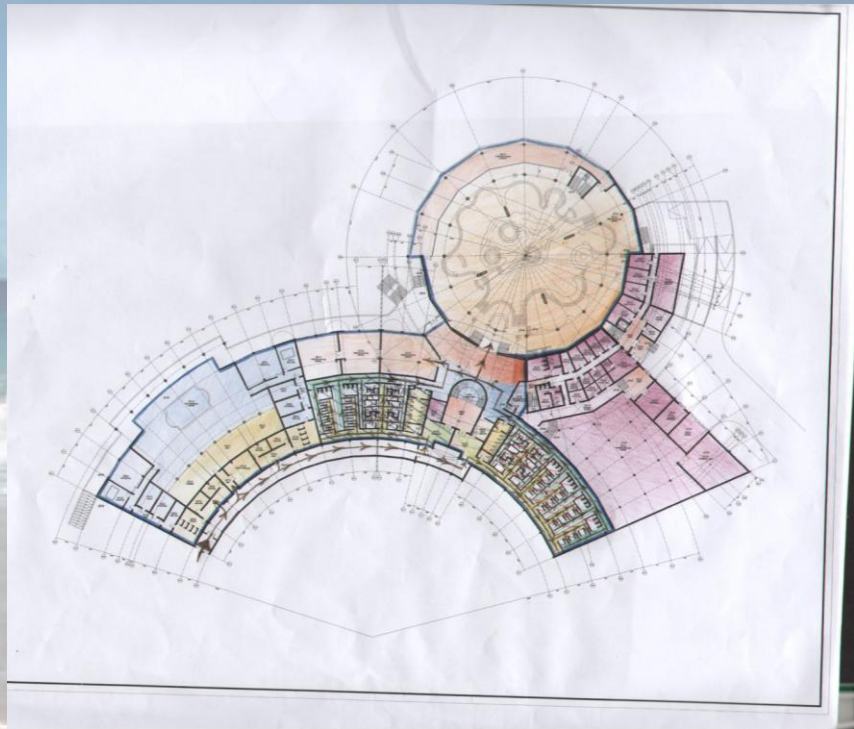

SPA

- الأنتقاضات
- مدخل الspa صغير جدا بالنسبة لحجم المبنى و غير ملائم
- ممر المستخدمين الى توصيل العلاج طويل و ضيق
- عدم وجود فصل بين dry area و ال wet area
- عدم الفصل بين السيدات و الرجال فى المنطقة المطهرة
- Relaxation area
- يدخل الناس الى منطقة ال Dry area بطريقة مباشرة

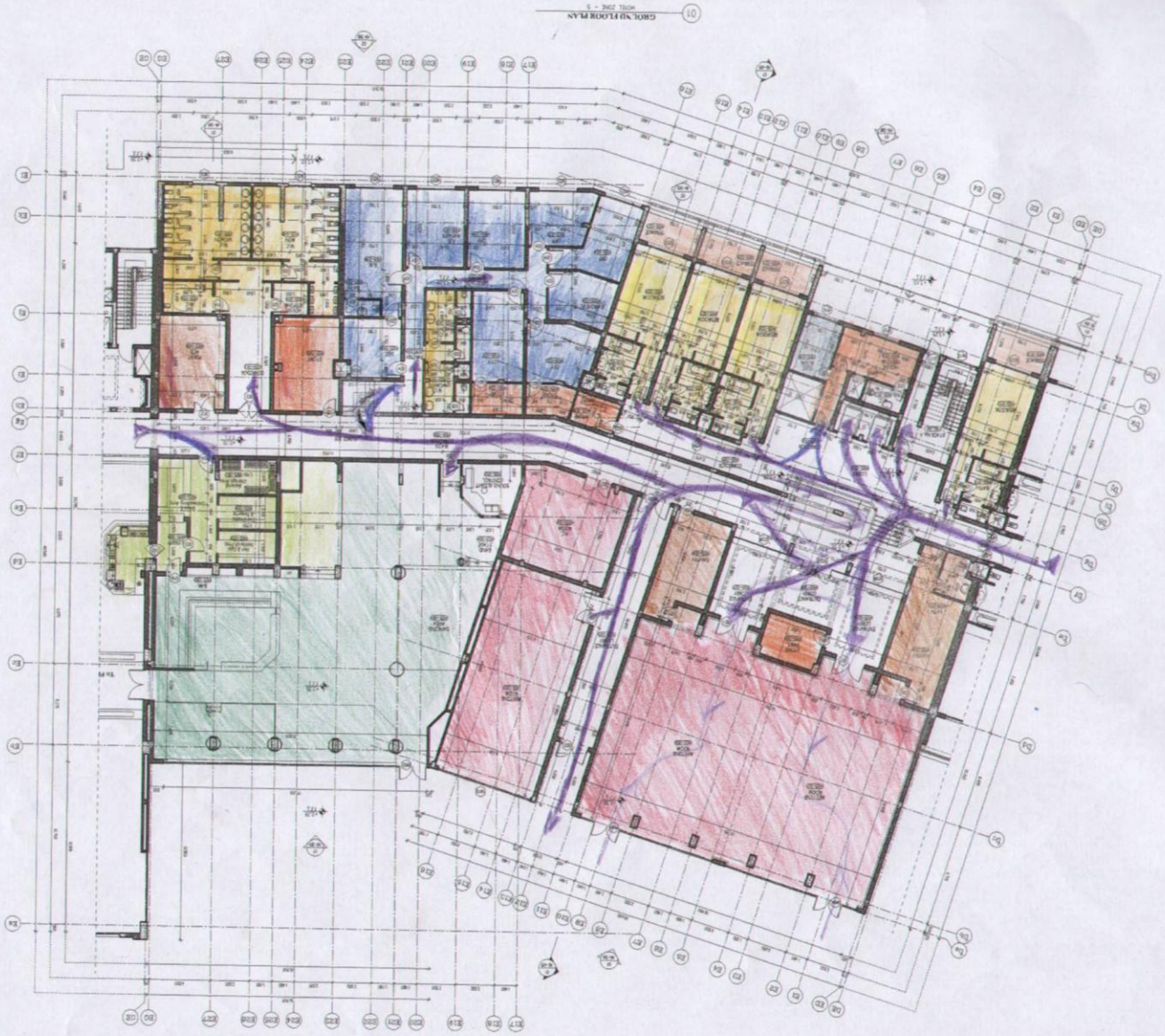

• منطقة الخدمة لهذه المنطقة فصلت بين منطقة
الغرف.

• ممرات الخدمات طويلة وغير مناسبة
للمستخدمين مع الخلط في العناصر وفئات
المستخدمين لكل فراغ (الأجنحة).

• وضع الغرف غير مناسب بالنسبة لباقي
العناصر المحيطة بها.

• موقع الإدارة جيد مع وجود بعض الغرف
بدون تهوية.

REV 01/20/04
REV 02/04/04
REV 03/04/04
REV 04/04/04

1
2
3
4
5
6
7
8
9
10
11
12
13
14
15
16
17
18
19
20
21
22
23
24
25
26
27
28
29
30
31
32
33
34
35
36
37
38
39
40
41
42
43
44
45
46
47
48
49
50
51
52
53
54
55
56
57
58
59
60
61
62
63
64
65
66
67
68
69
70
71
72
73
74
75
76
77
78
79
80
81
82
83
84
85
86
87
88
89
90
91
92
93
94
95
96
97
98
99
100

101
102
103
104
105
106
107
108
109
110
111
112
113
114
115
116
117
118
119
120
121
122
123
124
125
126
127
128
129
130
131
132
133
134
135
136
137
138
139
140
141
142
143
144
145
146
147
148
149
150

151
152
153
154
155
156
157
158
159
160
161
162
163
164
165
166
167
168
169
170
171
172
173
174
175
176
177
178
179
180
181
182
183
184
185
186
187
188
189
190
191
192
193
194
195
196
197
198
199
200

201
202
203
204
205
206
207
208
209
210
211
212
213
214
215
216
217
218
219
220
221
222
223
224
225
226
227
228
229
230
231
232
233
234
235
236
237
238
239
240
241
242
243
244
245
246
247
248
249
250



NO	DESCRIPTION
1	100-00-01
2	100-00-02
3	100-00-03
4	100-00-04
5	100-00-05
6	100-00-06
7	100-00-07
8	100-00-08
9	100-00-09
10	100-00-10
11	100-00-11
12	100-00-12
13	100-00-13
14	100-00-14
15	100-00-15
16	100-00-16
17	100-00-17
18	100-00-18
19	100-00-19
20	100-00-20
21	100-00-21
22	100-00-22
23	100-00-23
24	100-00-24
25	100-00-25
26	100-00-26
27	100-00-27
28	100-00-28
29	100-00-29
30	100-00-30
31	100-00-31
32	100-00-32
33	100-00-33
34	100-00-34
35	100-00-35
36	100-00-36
37	100-00-37
38	100-00-38
39	100-00-39
40	100-00-40
41	100-00-41
42	100-00-42
43	100-00-43
44	100-00-44
45	100-00-45
46	100-00-46
47	100-00-47
48	100-00-48
49	100-00-49
50	100-00-50
51	100-00-51
52	100-00-52
53	100-00-53
54	100-00-54
55	100-00-55
56	100-00-56
57	100-00-57
58	100-00-58
59	100-00-59
60	100-00-60
61	100-00-61
62	100-00-62
63	100-00-63
64	100-00-64
65	100-00-65
66	100-00-66
67	100-00-67
68	100-00-68
69	100-00-69
70	100-00-70
71	100-00-71
72	100-00-72
73	100-00-73
74	100-00-74
75	100-00-75
76	100-00-76
77	100-00-77
78	100-00-78
79	100-00-79
80	100-00-80
81	100-00-81
82	100-00-82
83	100-00-83
84	100-00-84
85	100-00-85
86	100-00-86
87	100-00-87
88	100-00-88
89	100-00-89
90	100-00-90
91	100-00-91
92	100-00-92
93	100-00-93
94	100-00-94
95	100-00-95
96	100-00-96
97	100-00-97
98	100-00-98
99	100-00-99
100	100-00-100

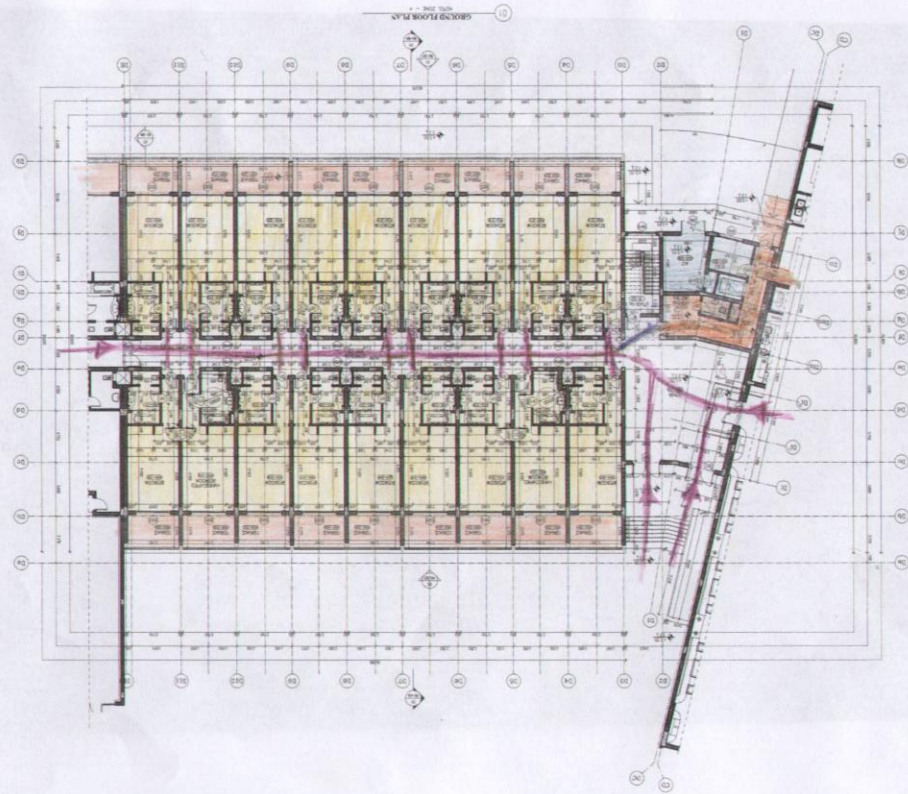

- Services ■
- Bed Rooms ■
- TERRACE ■
- Circulation guest →
- ETC. ROOM ■
- Circulation service →

• الممر المؤدى الى غرف النوم طويل جدا مع وجود فتحة في نهاية الممر وقد يقتصر الطريق على المستخدمين على حسب موضع الغرفة لأحدى المدخلين.

• السلم المؤدي للأدوار العليا مغلق بباب وهذا غير مناسب، مع أن فتح الحائط مكانها مناسب أكثر.



Our land Analyses

Climatic study for our project land

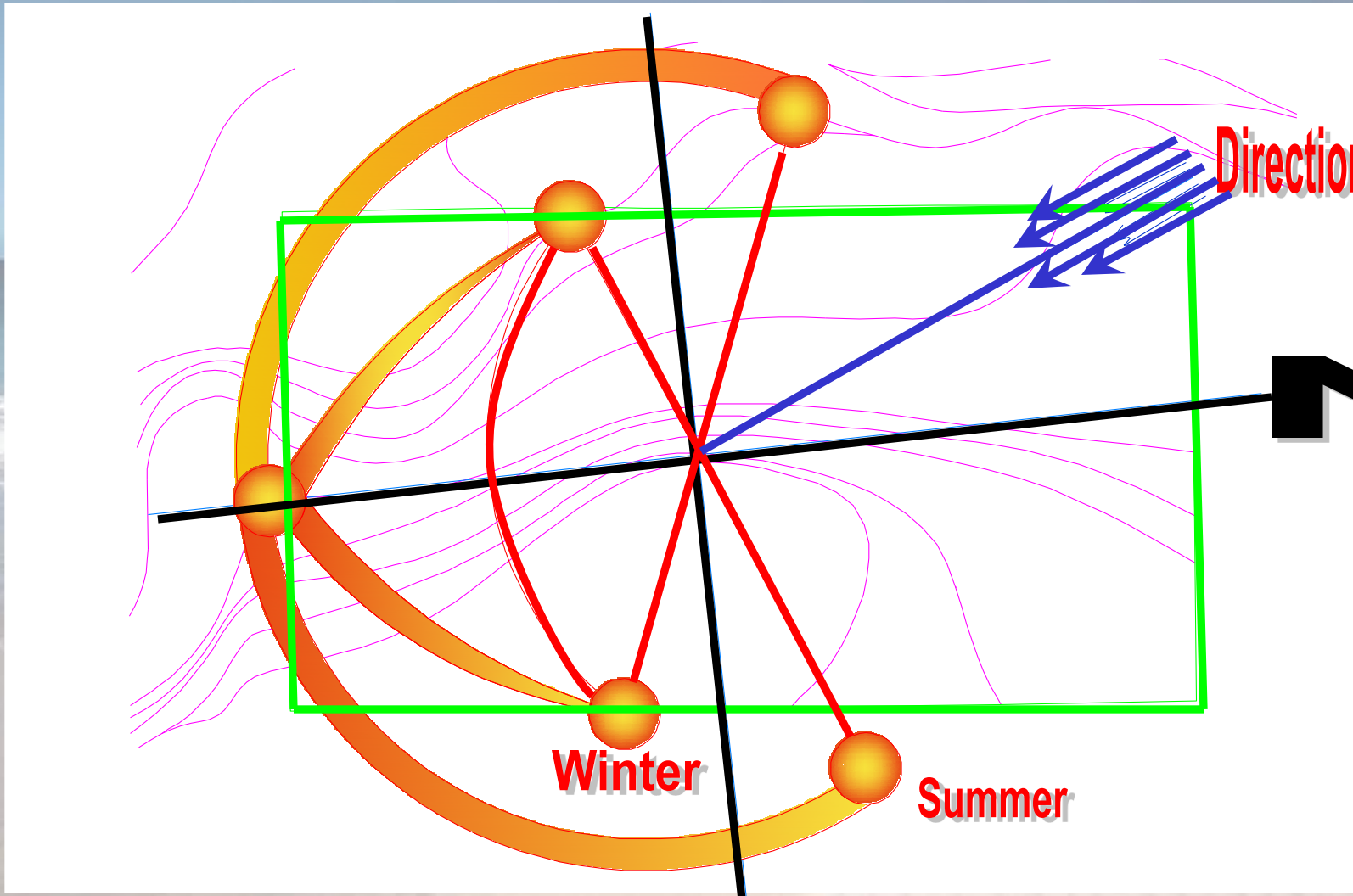

Direction of wind

Winter

Summer

N

المناخ

- يعتبر البحر الأحمر عنصر الجذب الوحيد في منطقة الصحراء الشرقية من خلال الجو المعتدل (المناخ) الذي يعتبر أهم عنصر لأي إقليم يقوم عليه النشاط السياحي والذي يجب ألا يعرقل النشاط السياحي و حركة السائح
- تشير متوسطات النهايات العظمي والصغرى لدرجات الحرارة بالهواء بالنسبة للهواء والماء أنها منطقة ملائمة للنشاط السياحي طوال العام أي أن متوسطات درجات الحرارة للهواء تتراوح بين (26-29 م)
- وتعتبر درجة حرارة (33م) هي أقصى درجة حرارة يصل لها الهواء في فصل الصيف .
- وتصل درجات الحرارة من (18-19 م) في فصل الشتاء وأقصى درجة حرارة في هذا الفصل (24م)
- اما درجة حرارة الماء تتراوح بين (18-20م) خلال العام وتصل الي اقصاها في فصل الصيف (25م) وتسمح هذه الدرجات بممارسة الأنشطة المائية.

Bubble diagram

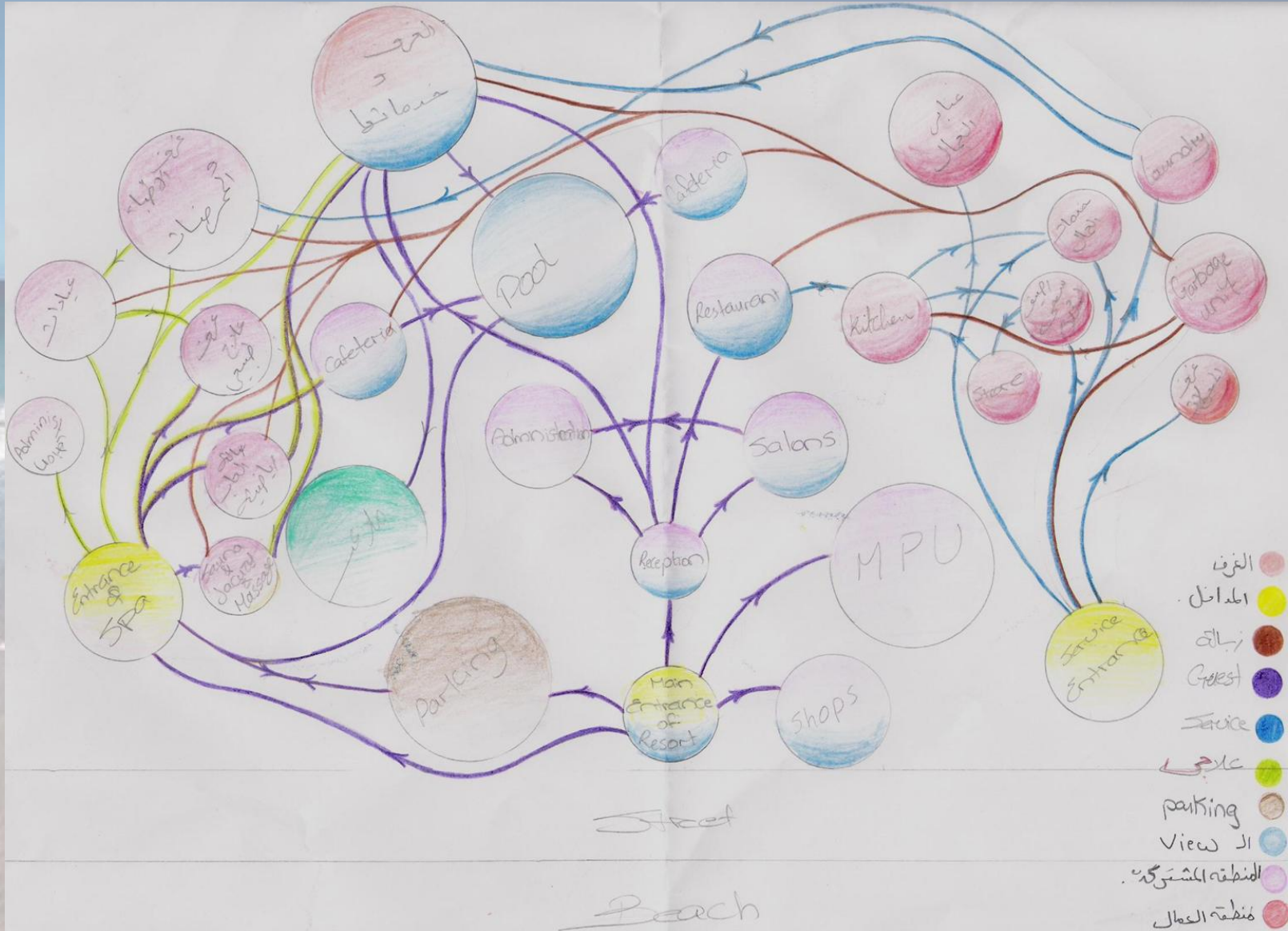

An aerial photograph of a beach with sand dunes and waves. The sky is blue with some clouds. The text "Data for Design" is overlaid in a large, bold, italicized black font.

Data for Design

An aerial photograph of a beach with sand dunes and waves. The sky is blue with some clouds. The word "Entrance" is written in a large, bold, italicized black font across the center of the image.

Entrance

Examples of entrances





Security area equipment dimensions

Items

Person's machine

Bags' machine

L

W

9.5m

8.5m

4.25m

3.10m

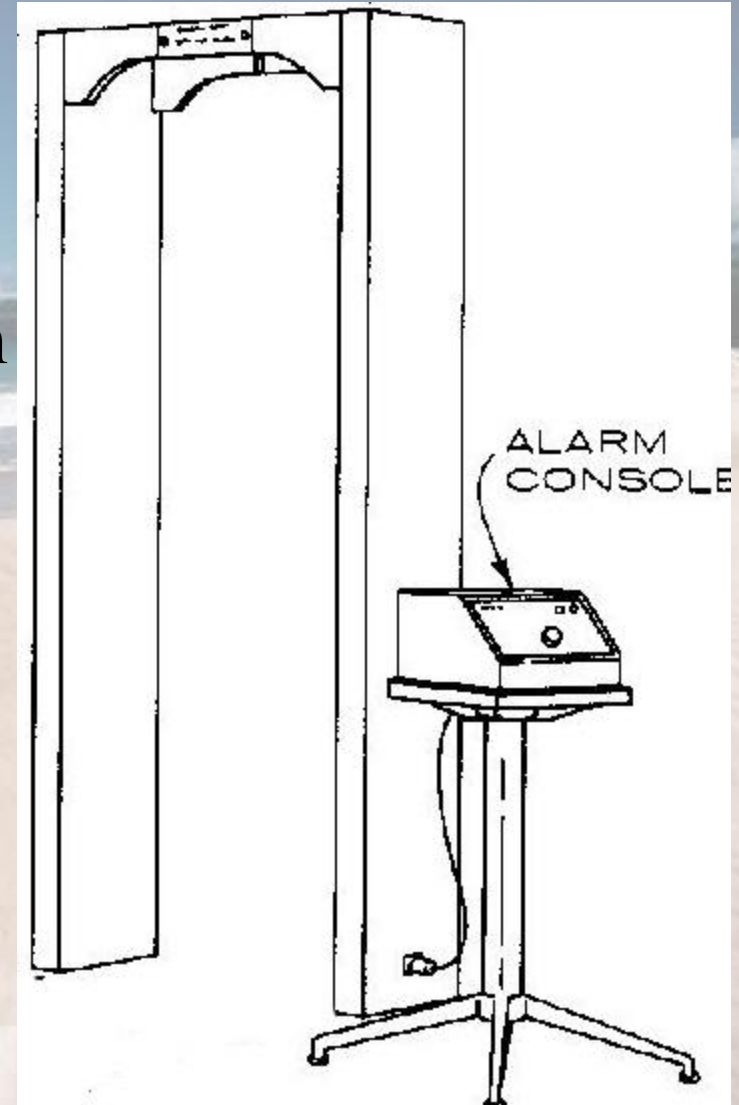
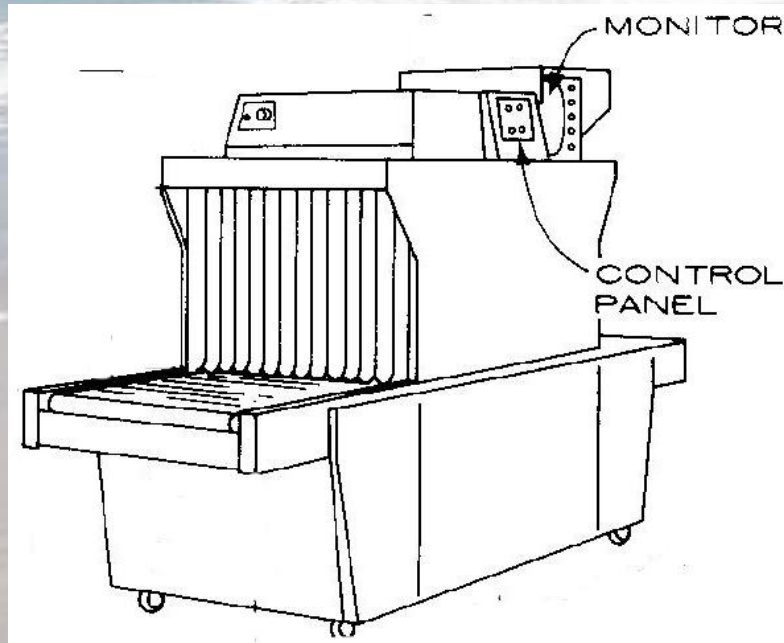



- Shape for entrance.



- Entrance contains a foyer.



- Entrance shows the direct relation with the information desk.



- Information desk for checking in & out.



- Entrance & foyer & their direct relation with the salons & waiting area.

Examples of salons





- View of the entrance & lobby and their direct relation with stairs that leads to the guest rooms



Restaurants

Shapes & Dimensions

Dimension of table & seats

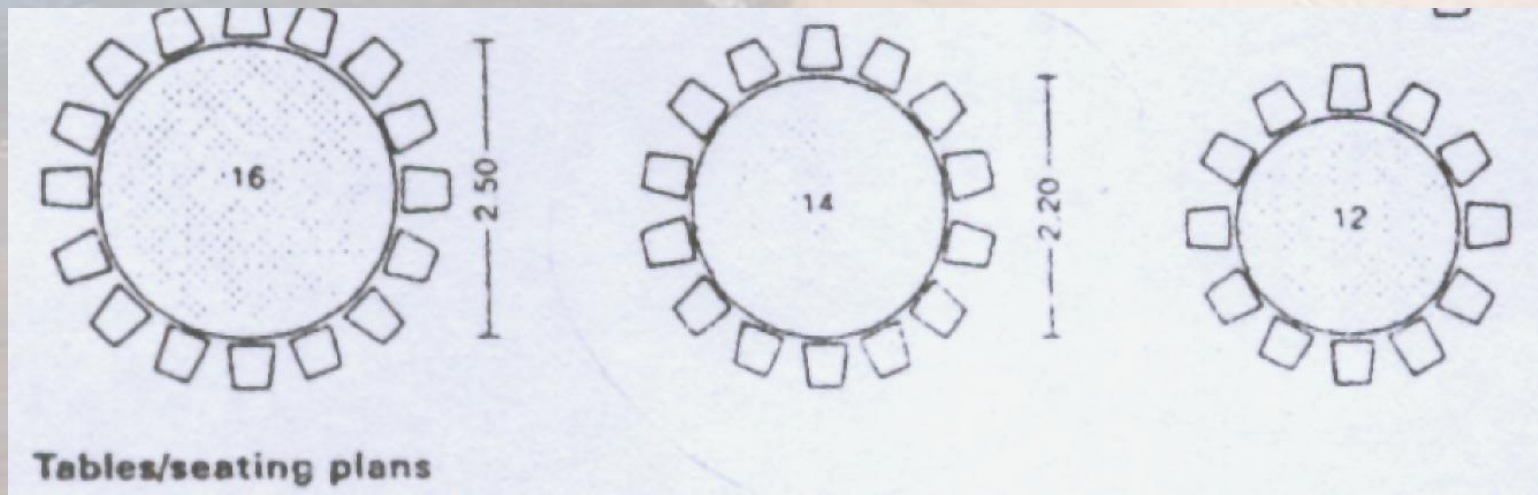
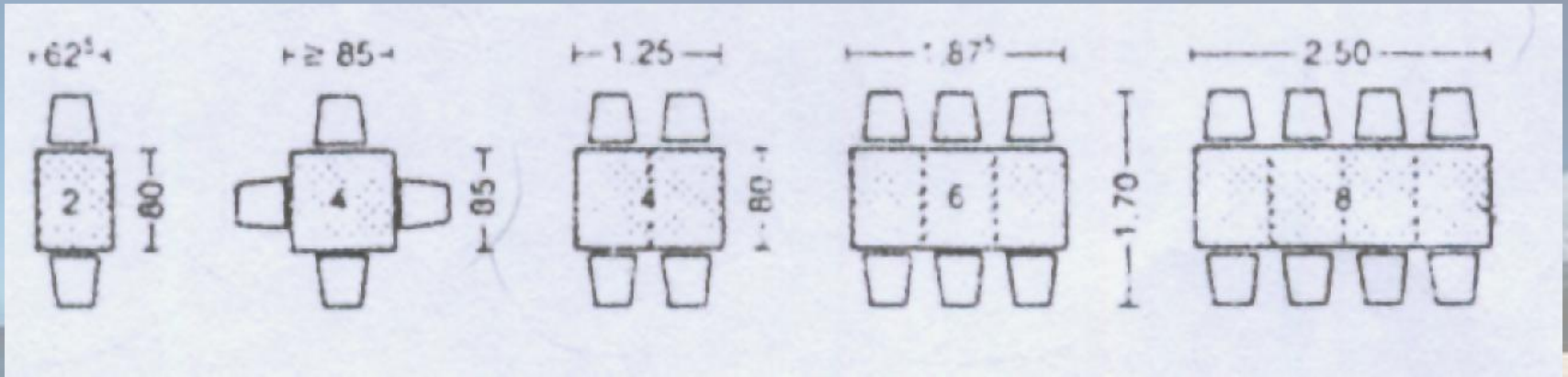

Dimensions between the unit & the other

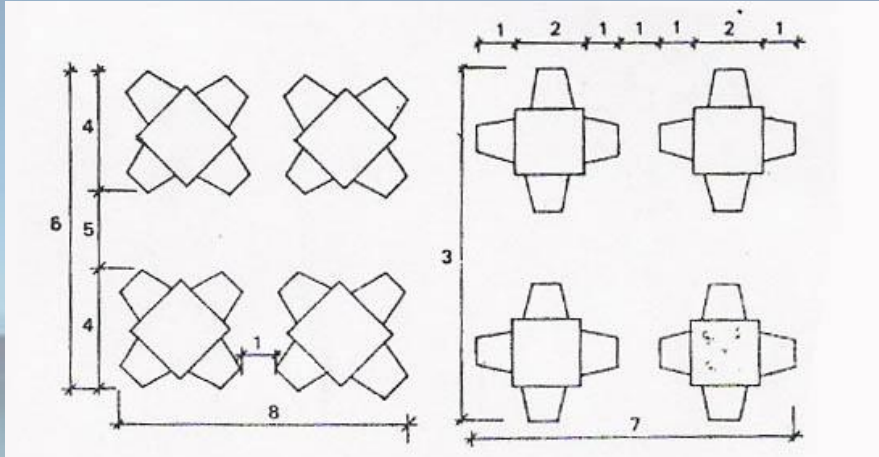

سنٲمٲرا ٧٦,٢٠ - 9

سنٲمٲرا ١٢٢,٠ - 10

سنٲمٲرا ٦١,٠٠ - 11

سنٲمٲرا ٥١٧,٠ - 12

سنٲمٲرا ٩٦,٥٠ - 13

سنٲمٲرا ١٣٧,٢ - 14

سنٲمٲرا ٤٤٠,٠ - 15

سنٲمٲرا ٤٥,٧٠ - 1

سنٲمٲرا ٨٦,٤٠ - 2

سنٲمٲرا ٢٤٧,٠ - 3

سنٲمٲرا ١٥٢,٠ - 4

سنٲمٲرا ٩١,٥٠ - 5

سنٲمٲرا ٣٩٦,٠ - 6

سنٲمٲرا ٤٠١,٥ - 7

سنٲمٲرا ٣٥٠,٥ - 8

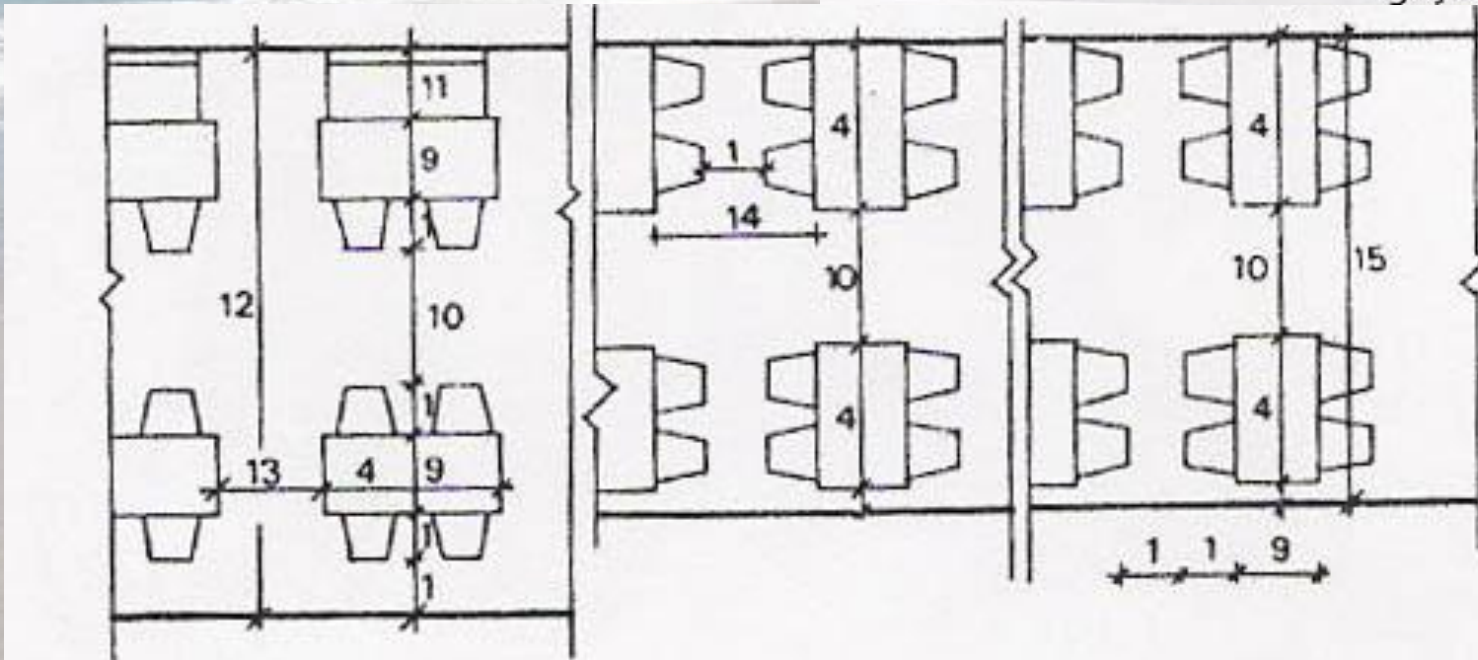

Different examples of restaurant plans

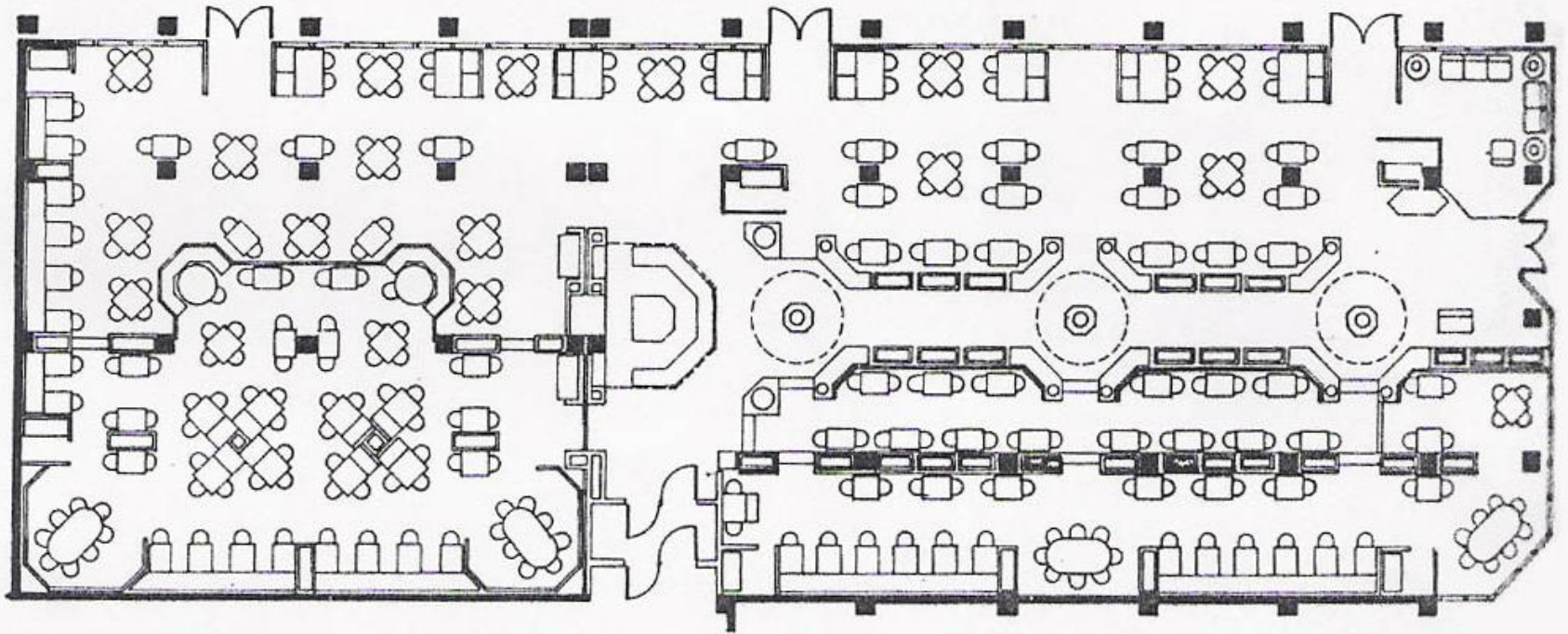

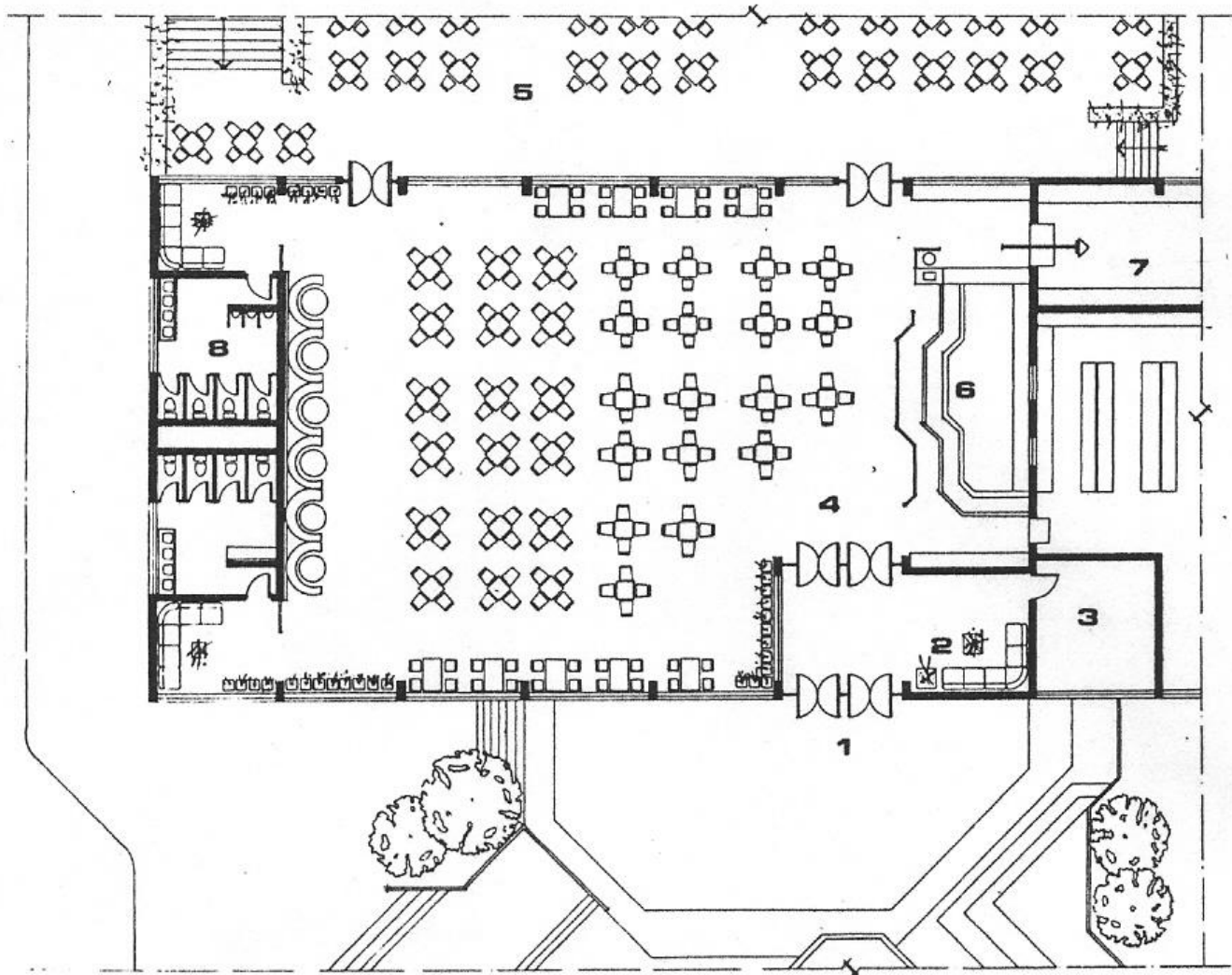

- 1 - مدخل رئيسي
- 2 - صالون انتظار
- 3 - غرفة معاطف
- 4 - صالة الطعام الرئيسية
- 5 - الامتداد الخارجي
- 6 - كاونتر تقديم
- 7 - غسل أواني ومطبخ
- 8 - دورات مياه

مسقط أفقي

Examples of restaurants







Kitchen

Shapes & Dimensions

Relation between the kitchen & the dinning room

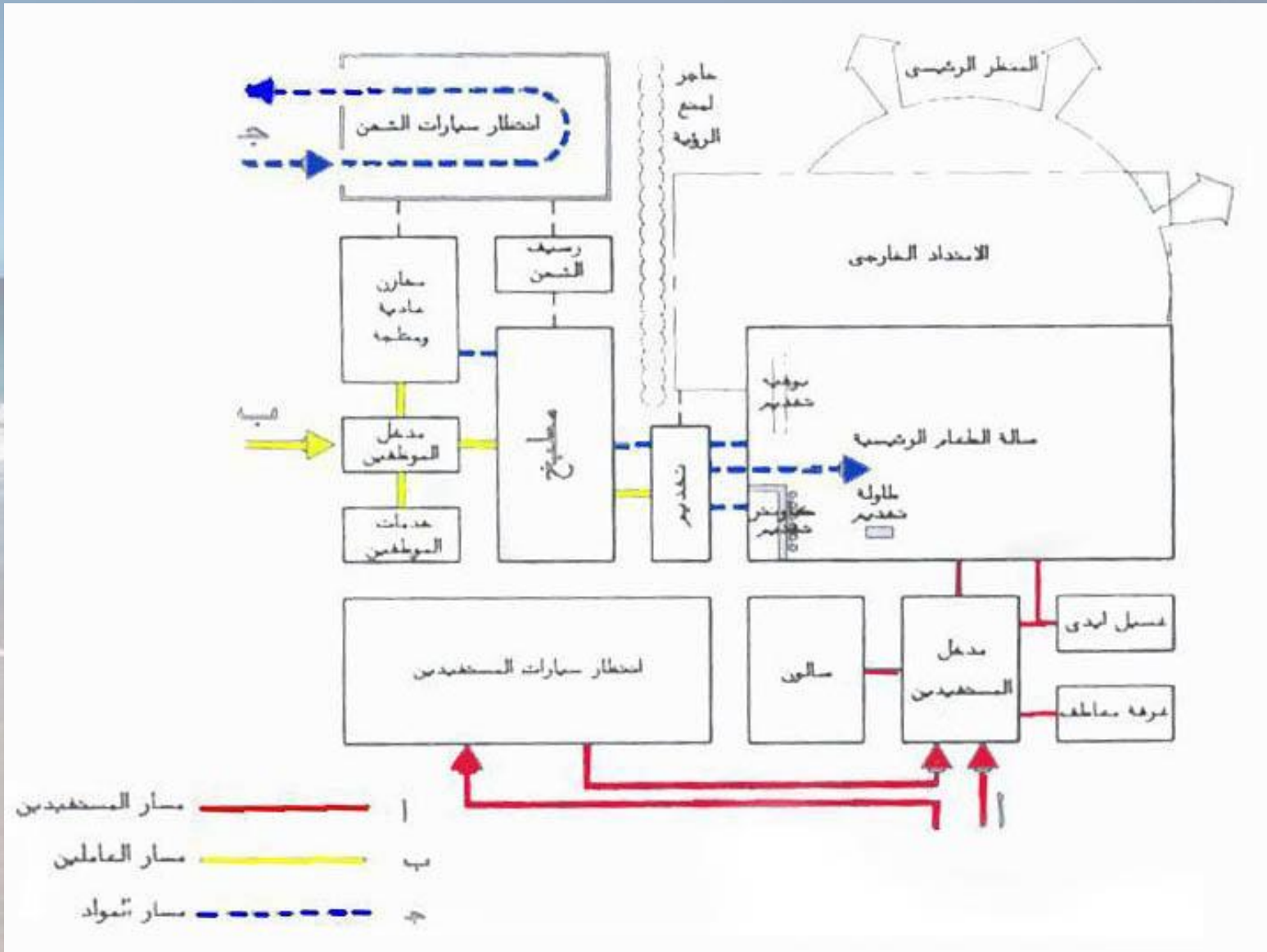

Relation between the kitchen & the dinning room

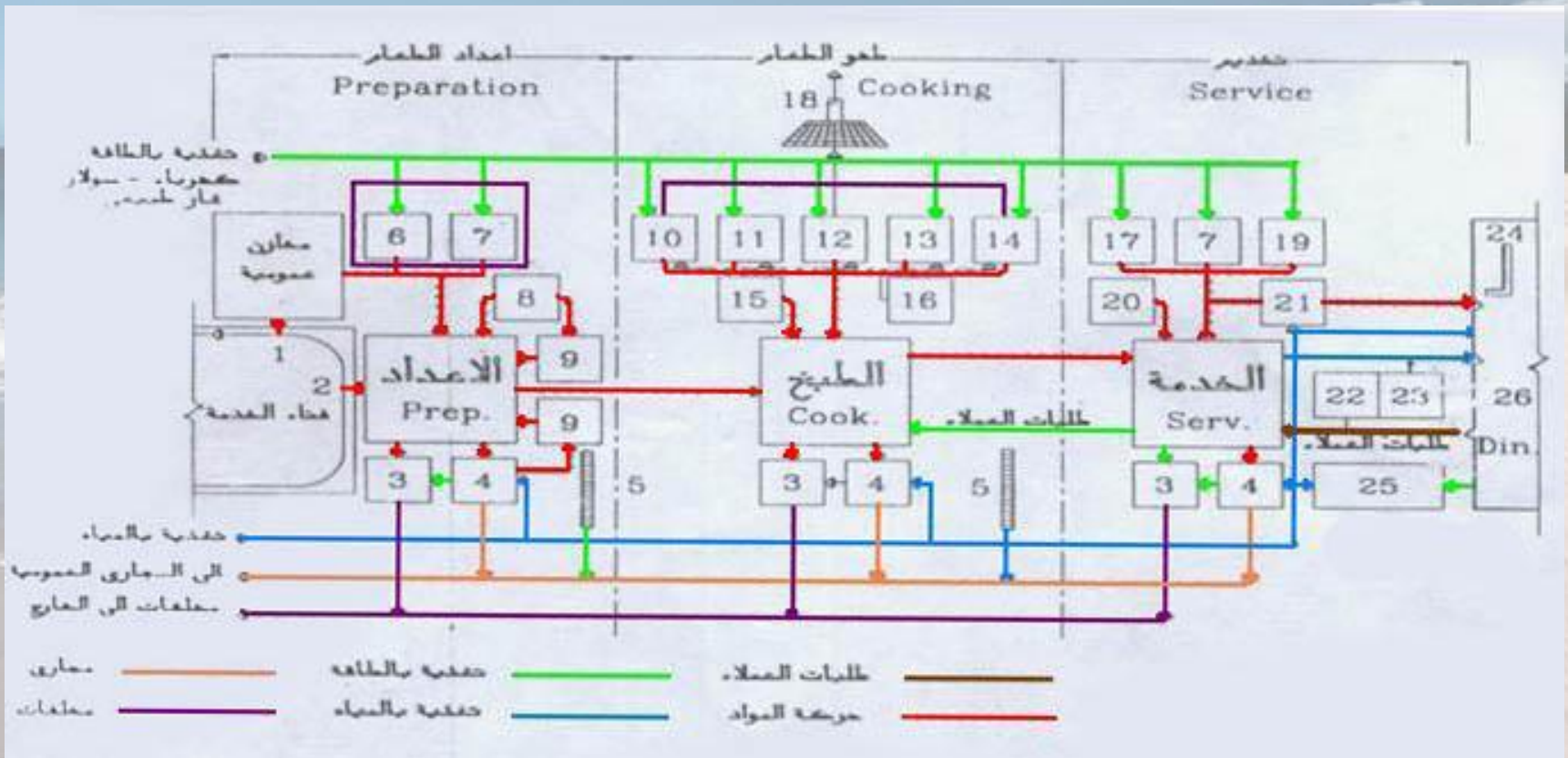

Kitchen entrance

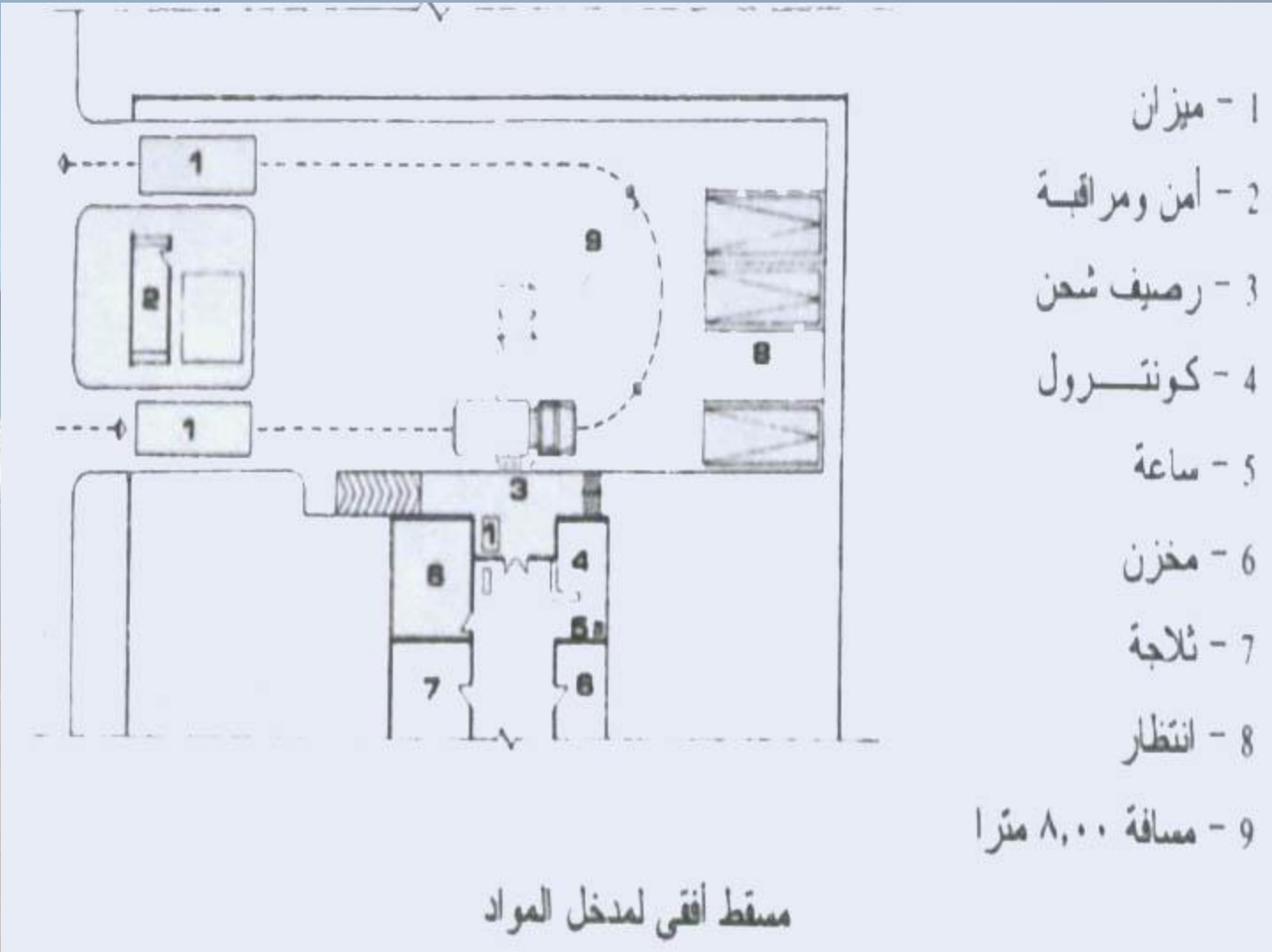

Platform cargo

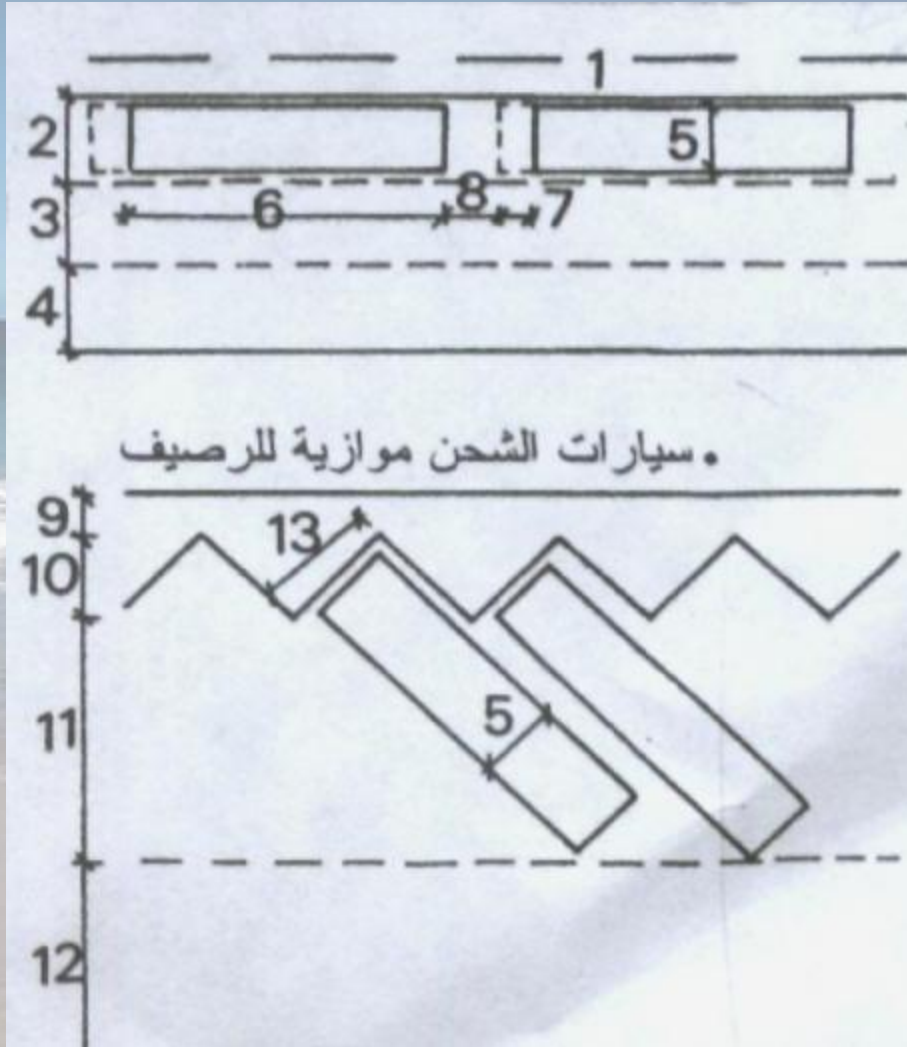

رصيف الشحن

يجب أن يتصل رصيف الشحن
بطريق فرعي يتصل هذا الطريق
بالمدخل الرئيسي للمشروع لتسهيل
حركة الشاحنات

الي رصيف الشحن بدون عمل أي
خلل في نظام المشروع



***Kitchen
circulation study***

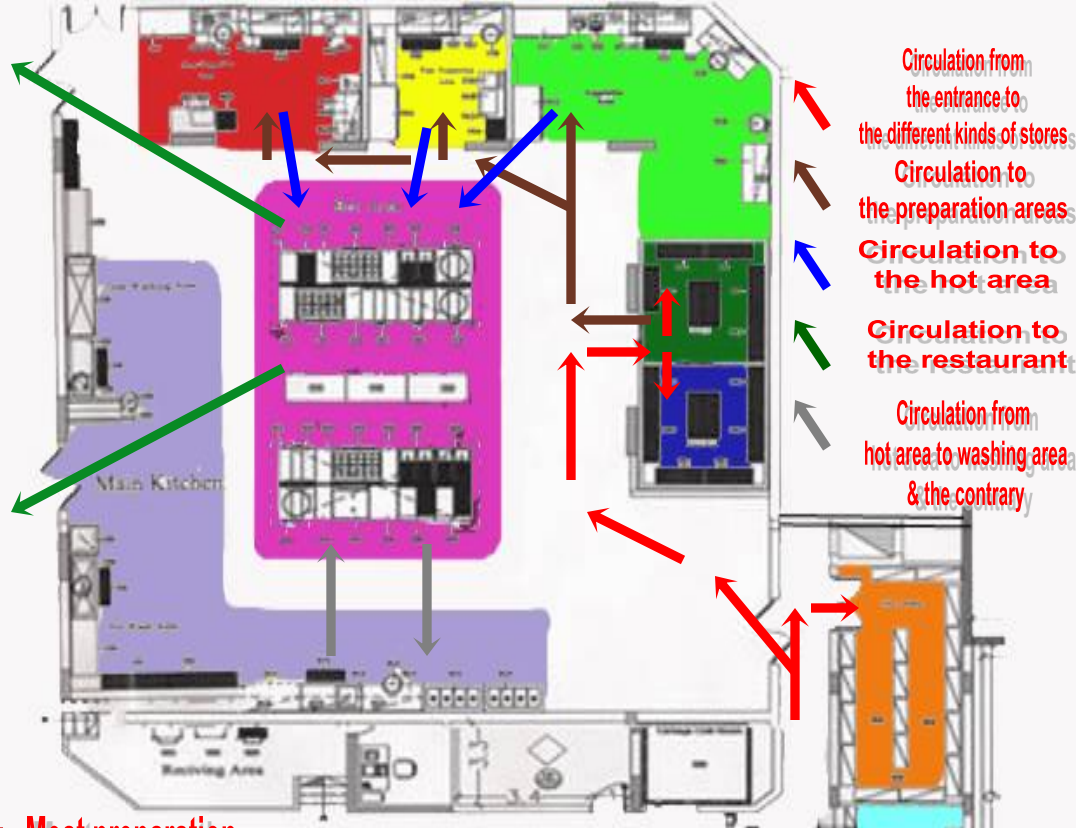

- Meat preparation
- Hot area
- Vegetables preparation
- Vegetable store
- Fish store
- Office keeper
- Fish preparation
- Dish washing area
- Dry Store

Washing Area	
SA.1	Meat Washing Trolley
SA.2	Plank Wash Basin
SA.3	Air Trolley
SA.4	Garbage Trolly Room
SA.5	Wash Pad
SA.6	Vegetables Wash Room
SA.7	Vegetables Cold Room
SA.8	Fish Washing Room
SA.9	Washing table
SA.10	Washing table
SA.11	Meat Cold Room
SA.12	Washing table
SA.13	Washing table
SA.14	Washing table

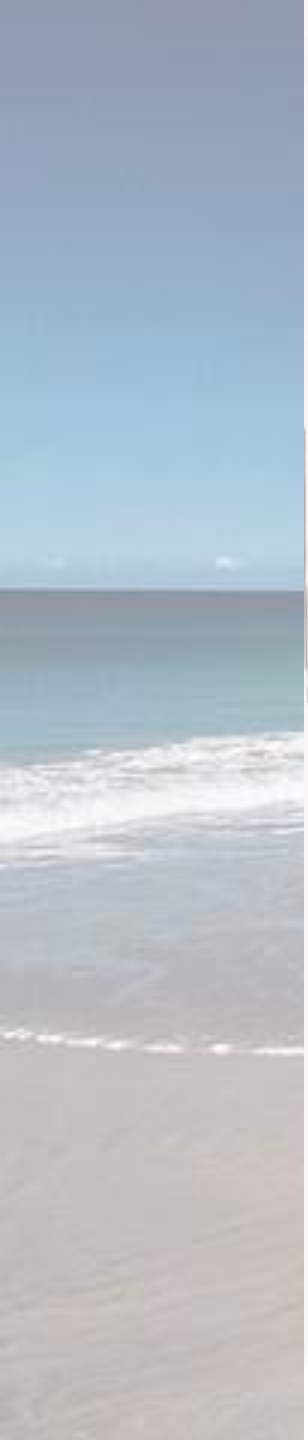
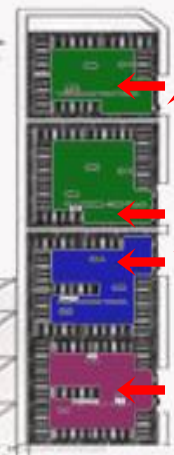

Standard areas to produce 200 meals

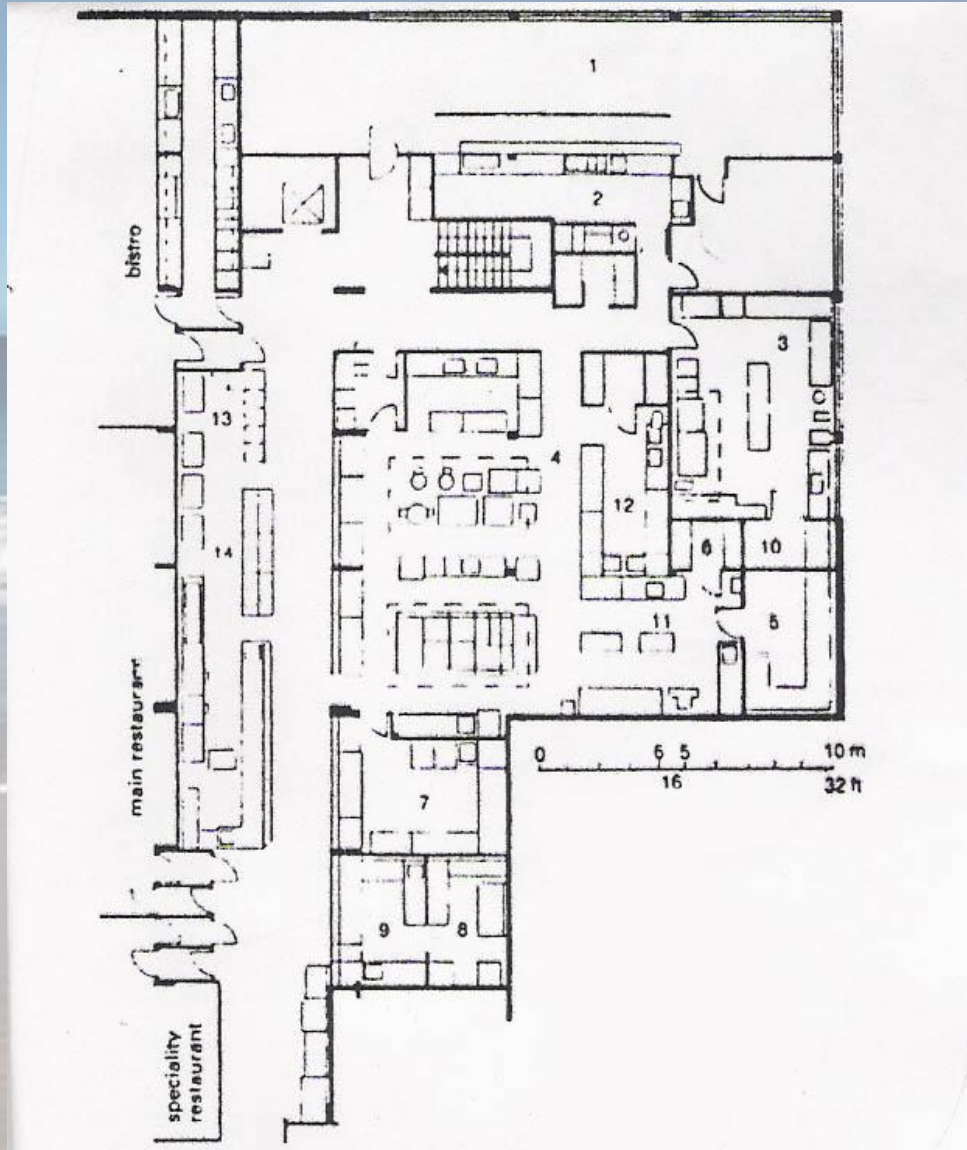

1. Staff Dining Room 4.4 x 19
2. Staff Kitchen 2 x 8
3. Bakery 4 x 5.6
4. Kitchen 8 x 12
5. Meat Cold Store 3.2 x 4.4
6. Fish Cold Store 1.6 x 2.4
7. Pantry 6 x 4.8
8. Drinks Cold Store 2.2 x 4.4
9. Drink Served 4 x 3.2
10. Dairy Products 1.6 x 3.2
11. Meat Preparation 4 x 5.6
12. Vegetarian Dish Preparation 2.8 x 7.6
13. Glass Washing Area 3.2 x 4
14. Dish Washing 3.2 x 11.6

Standard equipment dimensions

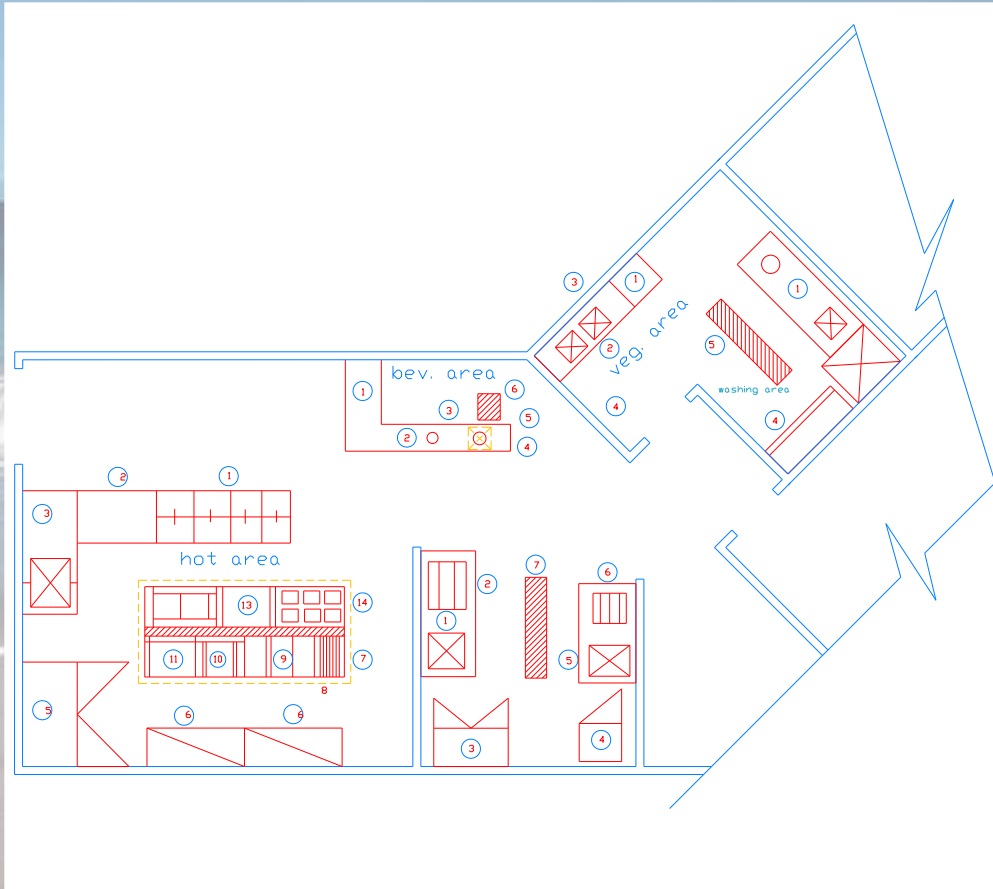

:Vegetable Area

Work Table 100 x 70 x 85 cm

Double Sink Unit 280 x 70 x 85 cm

Wall Shelf Unit 200 x 40 x 60 cm

Potato Peeler W/Drain 30 x 30 x 20 cm

:Beverage Area

Under Counter Fridge 120 x 70 x 85 cm

Water Boiler 28 Ltr

Bar Blender

Orange Juicer

Basin 70 x 70 x 85 cm

Floor Drain 30 x 30 x 20 cm

:Butcher & Fisher Area

Single Sink Unit 110 x 70 x 85 cm

Chopping Plate 50 x 50 x 15 cm

Reach in Fridge 140 x 70 x 205 cm

Rich in Fridge 70 x 70 x 205 cm

Sink Unit 120 x 70 x 85 cm

Chopping Plate 50 x 50 x 15 cm

Floor Drain 100 x 30 x 20 cm



Administration

Shapes & Dimensions

Dimensions of the manager's office

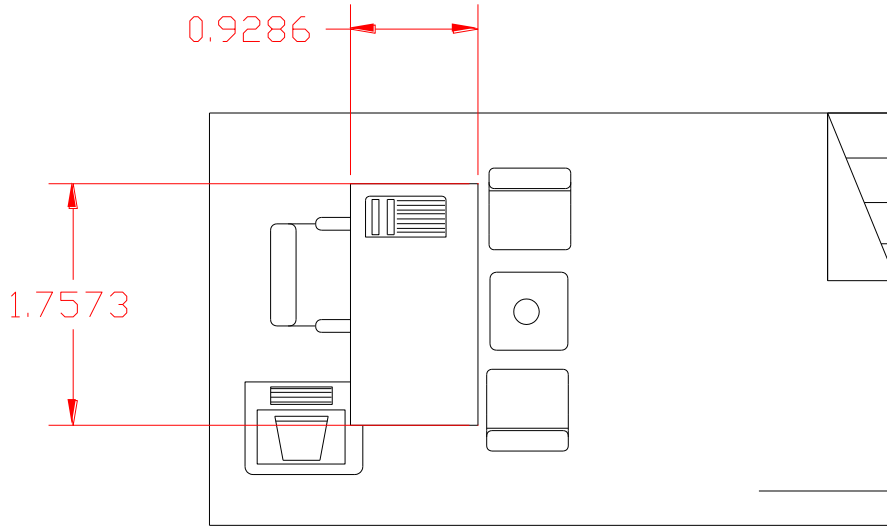

المساحات الضرورية :

موظف عادي 2.30m²

موظف ذو تعامل مع الجمهور 2.50m²

سكرتاريا 10m²

موظف بمكتب خاص 6 – 9m²

موظف مشتركة مع موظفين آخرين 5m²

مدير 13.50m²

سكرتارية 26,70m²

مدير خدمات 29,30m²

Exemple of an administration area

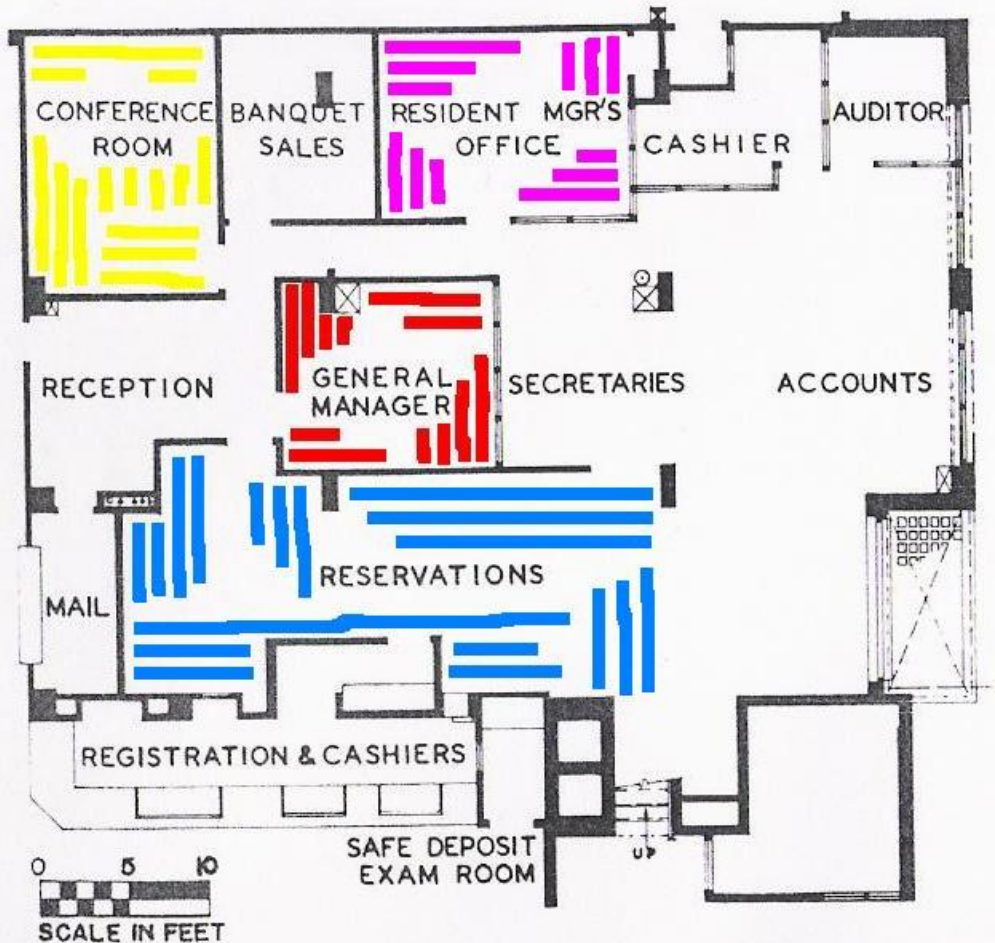

The Churchill Hotel, London.

مثال لمنطقة إدارية :

- وجود المدير في منتصف القسم الإداري يتيح له الفرصة لممارسة عمله الإداري و متابعة الحركة
- وضع السكرتارية على علاقة مباشرة مع المدير وفي علاقة مع باقي الموظفين حتى تستطيع تنظيم الاعمال
- يفضل تبديل مكان السكرتارية مع المدير حتى تكون السكرتارية متصلة بالاستقبال

Dimensions of the employees' offices

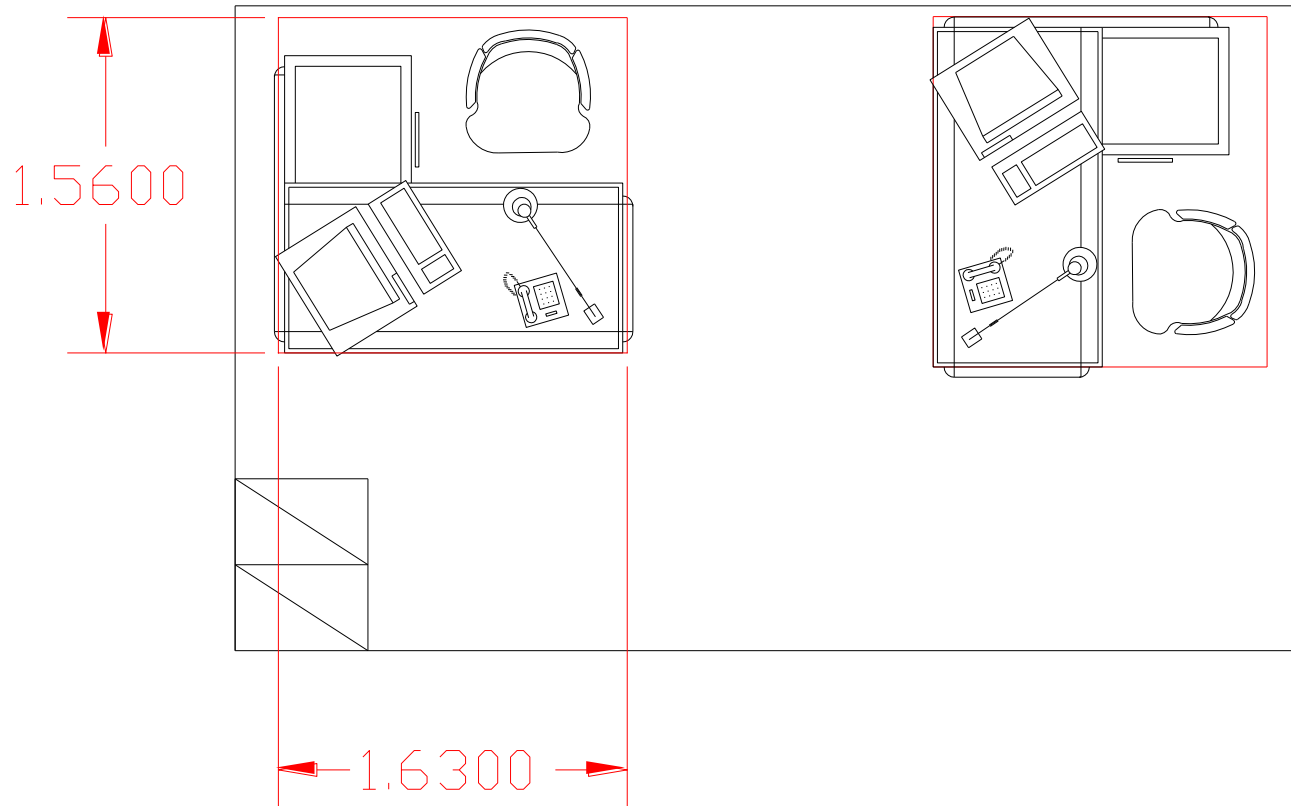

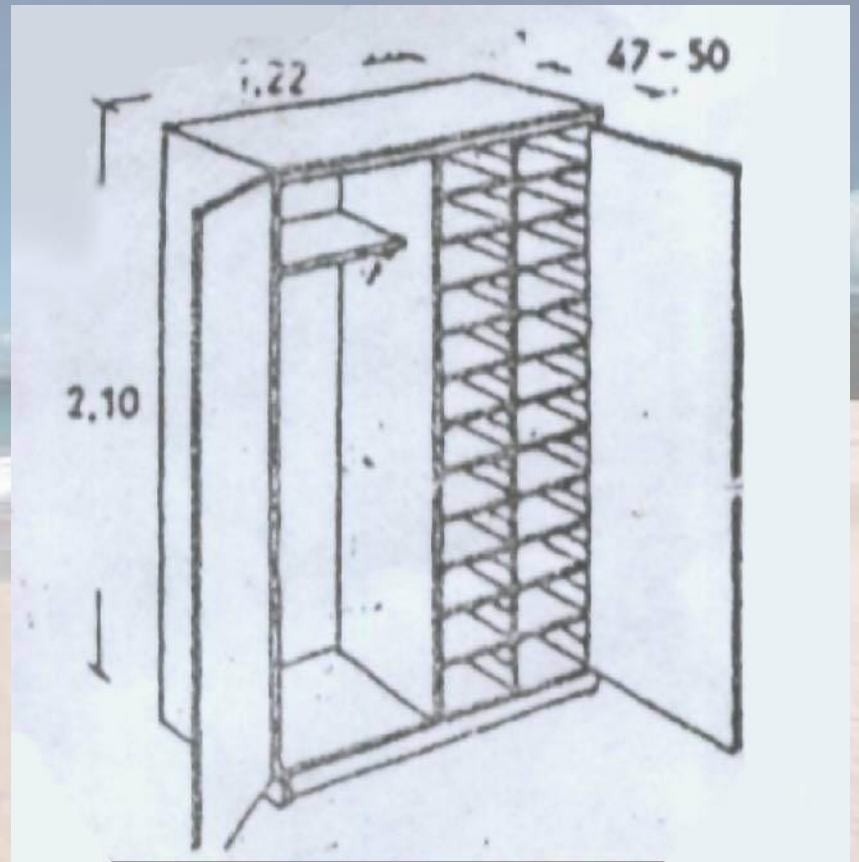
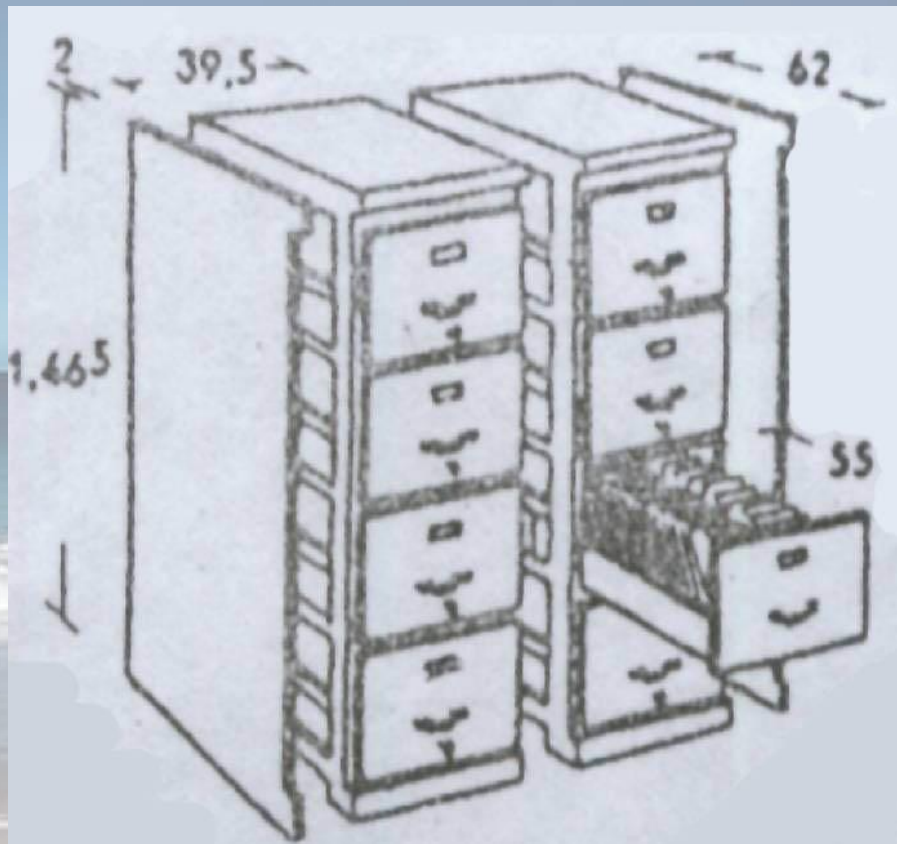

Exemples of offices





Bedrooms

Shapes & Dimensions

a. Shapes of single rooms.

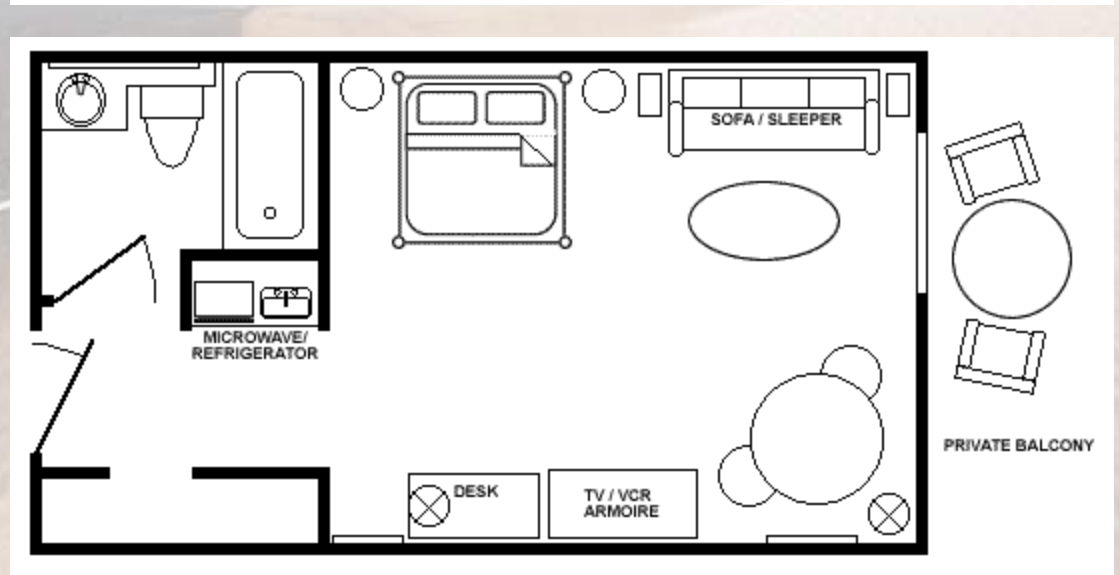
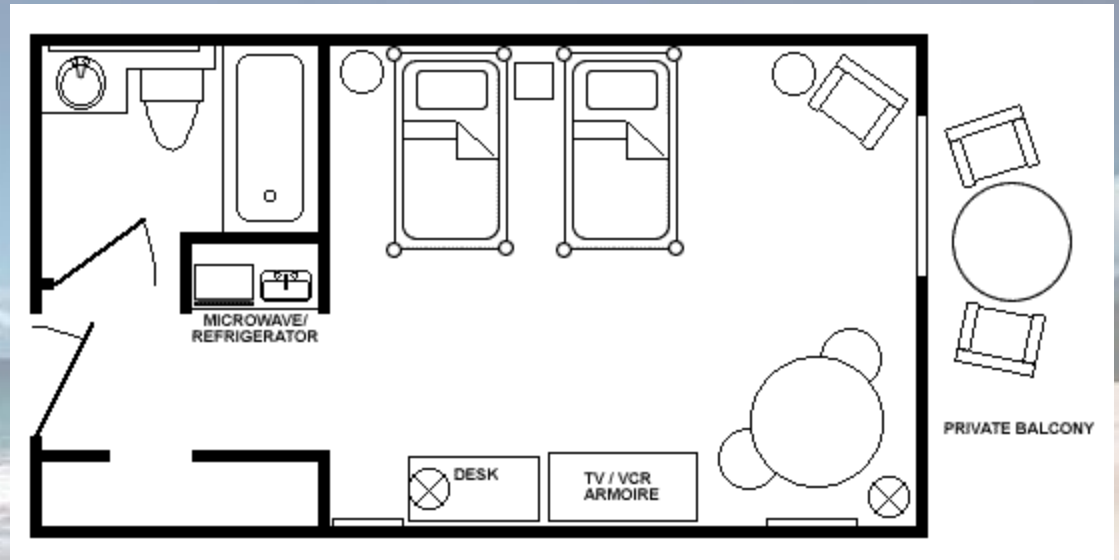
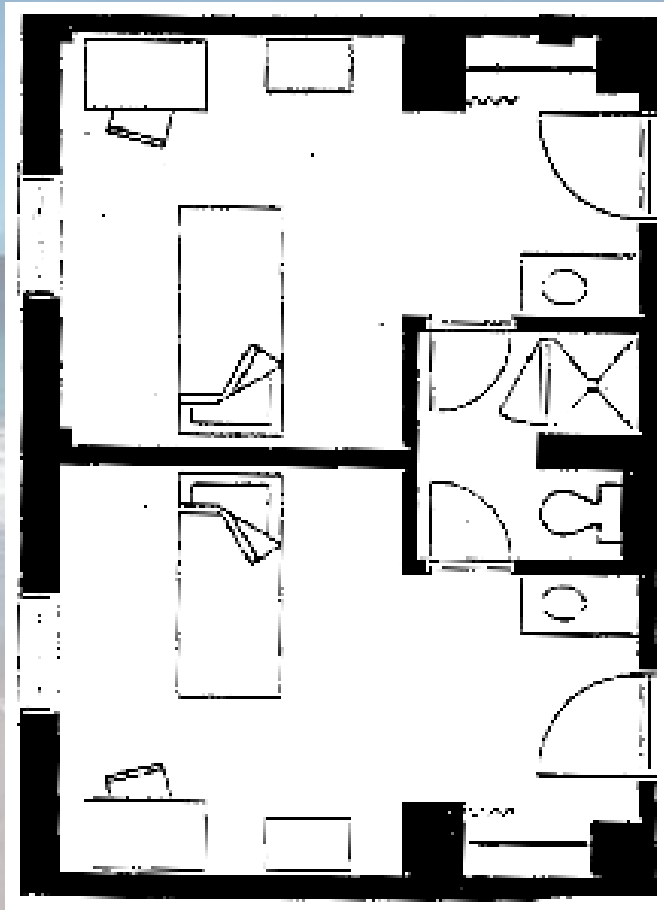

Example of single room standard dimensions

<u>Items</u>	<u>L</u>	<u>W</u>
Room	6 m	4 m
Bathroom	3 m	2.5 m
Bed	1.90 m	1.20 m

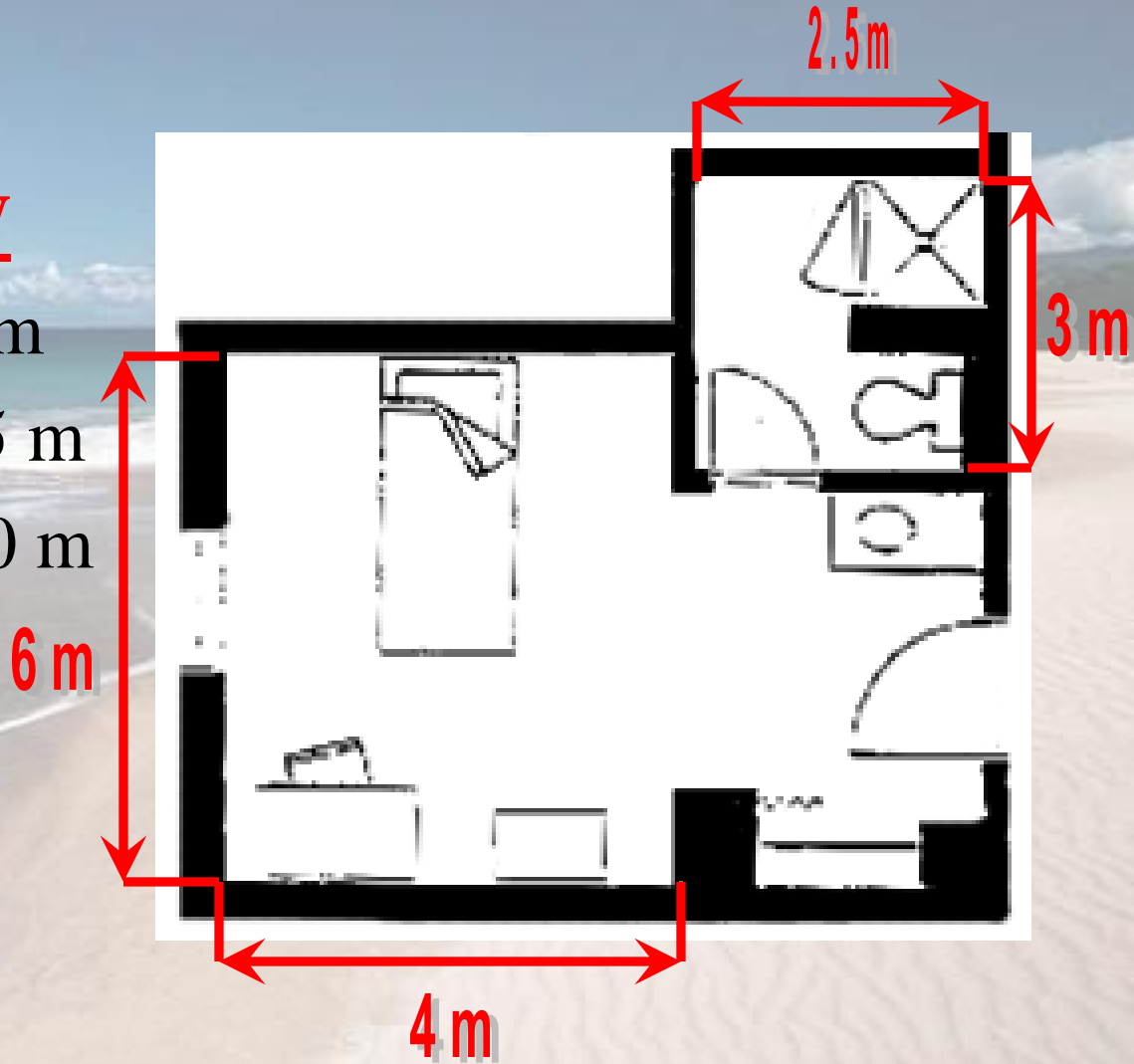

In case of having a hadicaped area in the room the bed clearances from the rest of the room as follow

1 m to 1.5 m

Bed Clearances

Distance

Wright side

1.33 m

Left side

min. 0.5 m to 1 m

Bottom

min. 1 m to 1.5 m

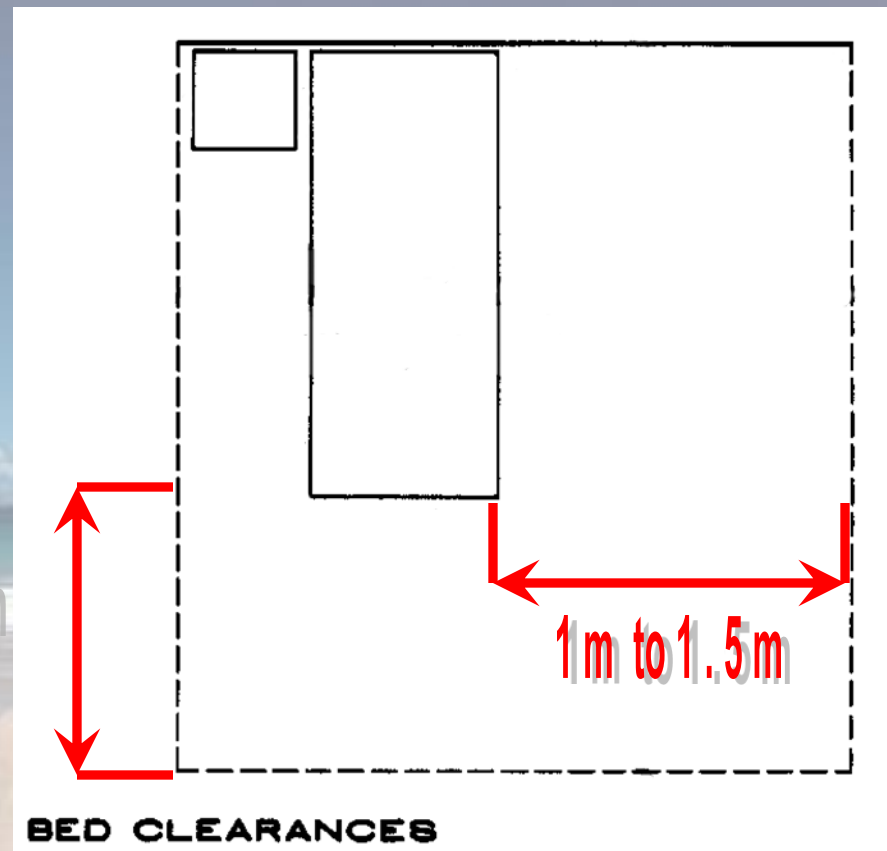

b. Shapes of double rooms

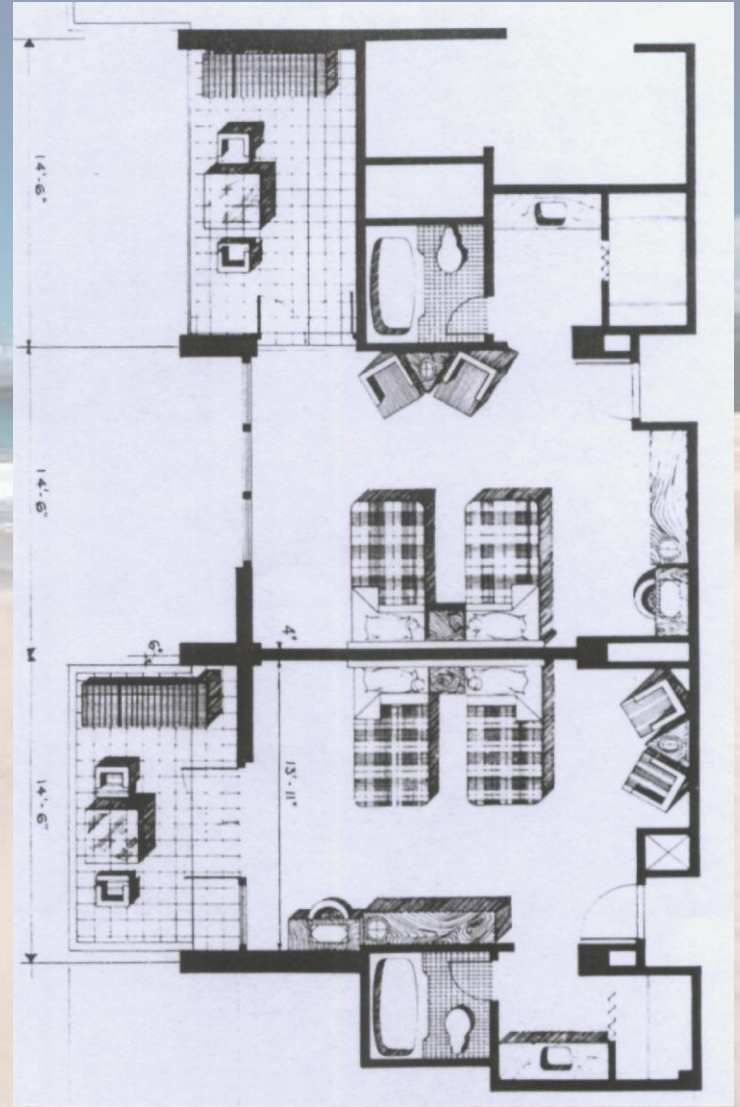
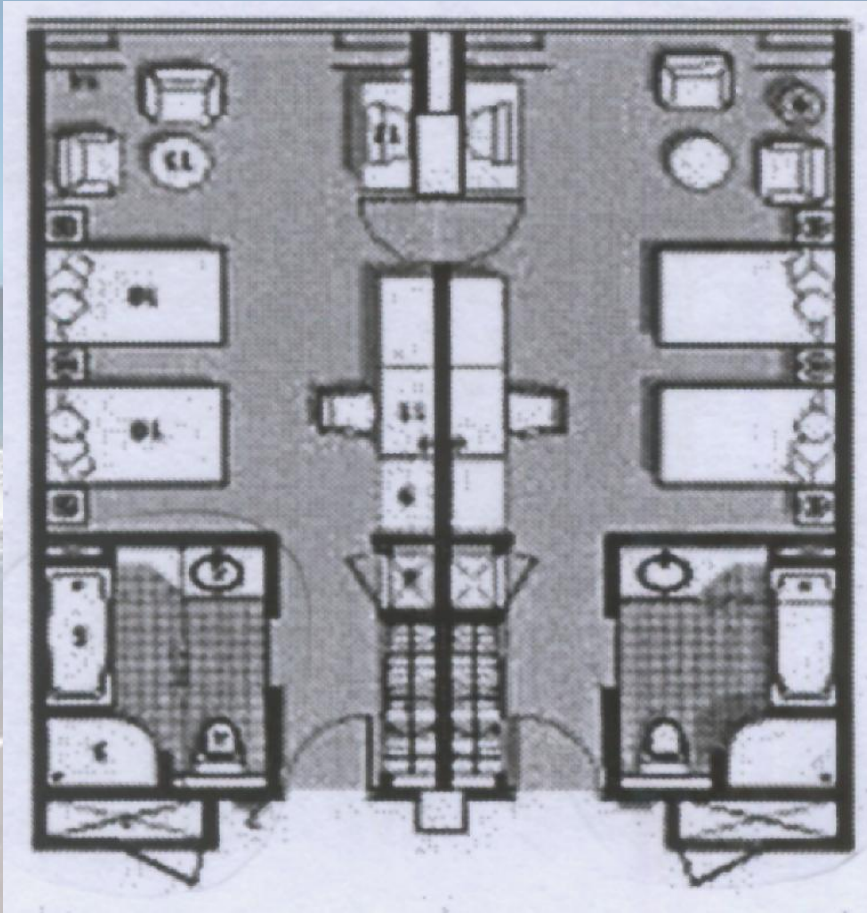

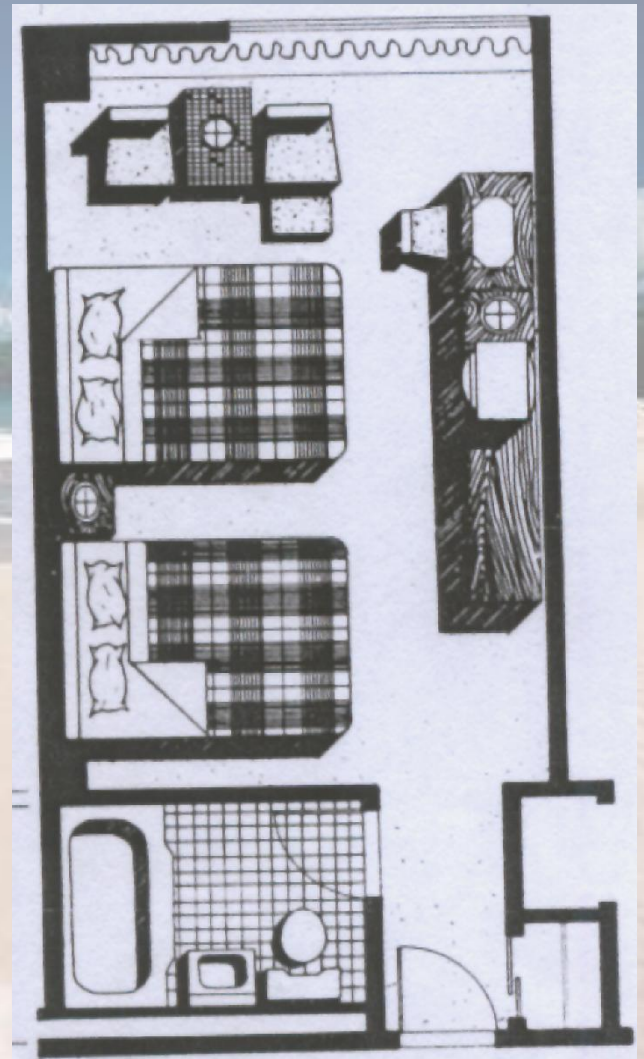
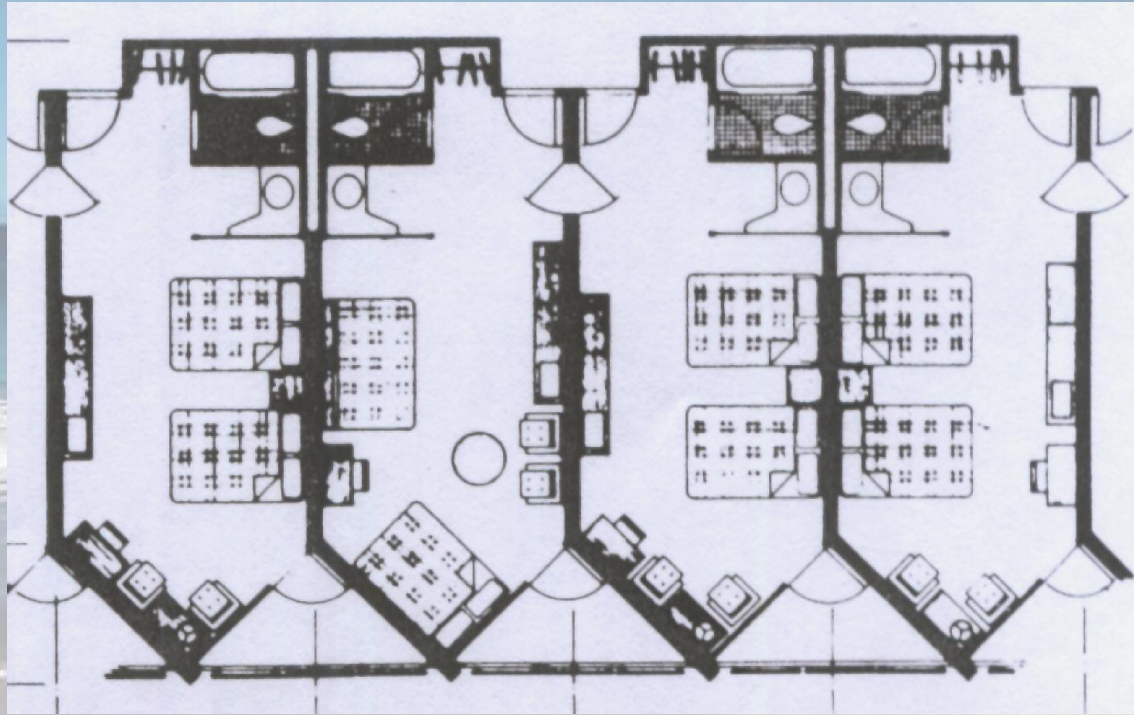

Example of double room standard dimensions

<u>Items</u>	<u>L</u>	<u>W</u>
Room	10m	4m
Bathroom	3m	2.5m
Bed	1.90m	1.20m

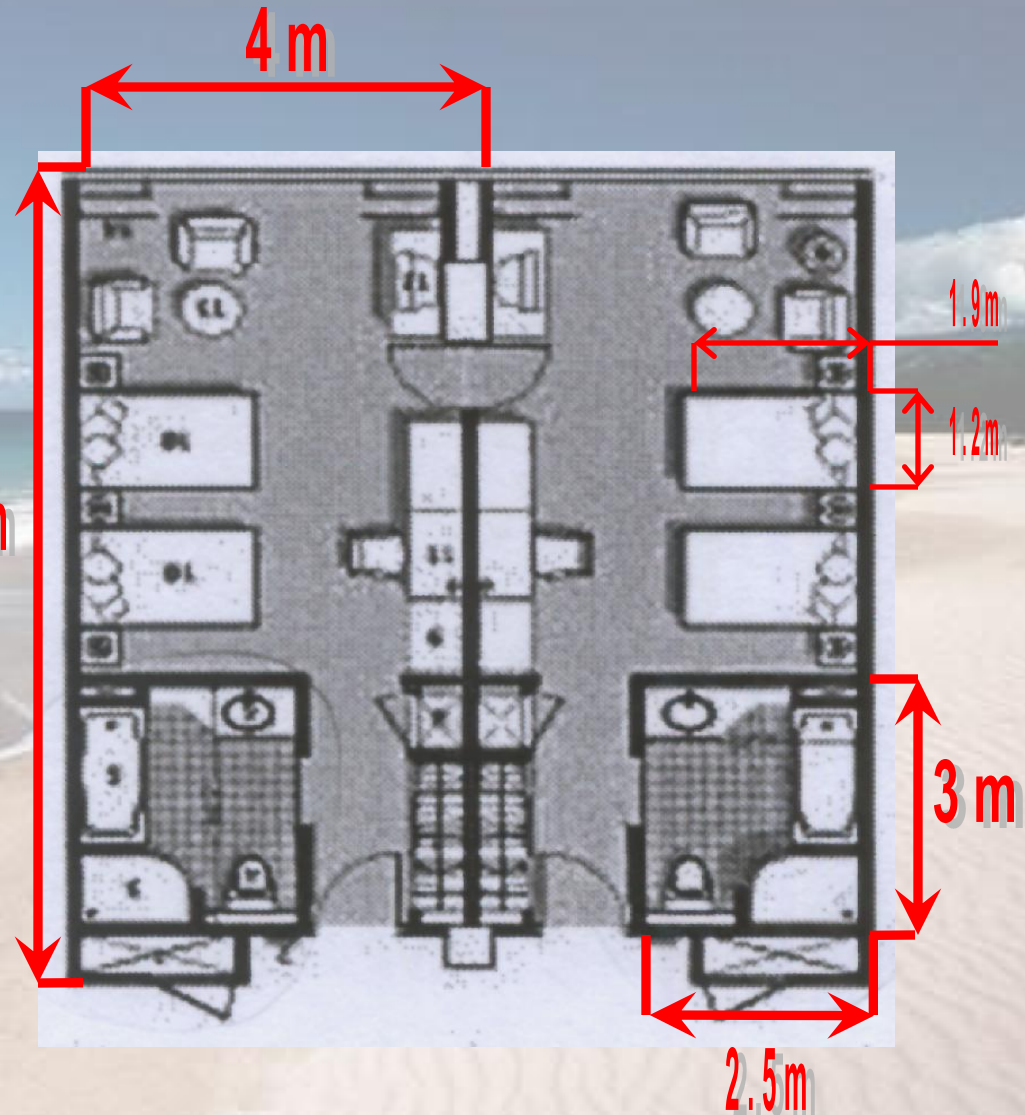

b. Shapes of suites

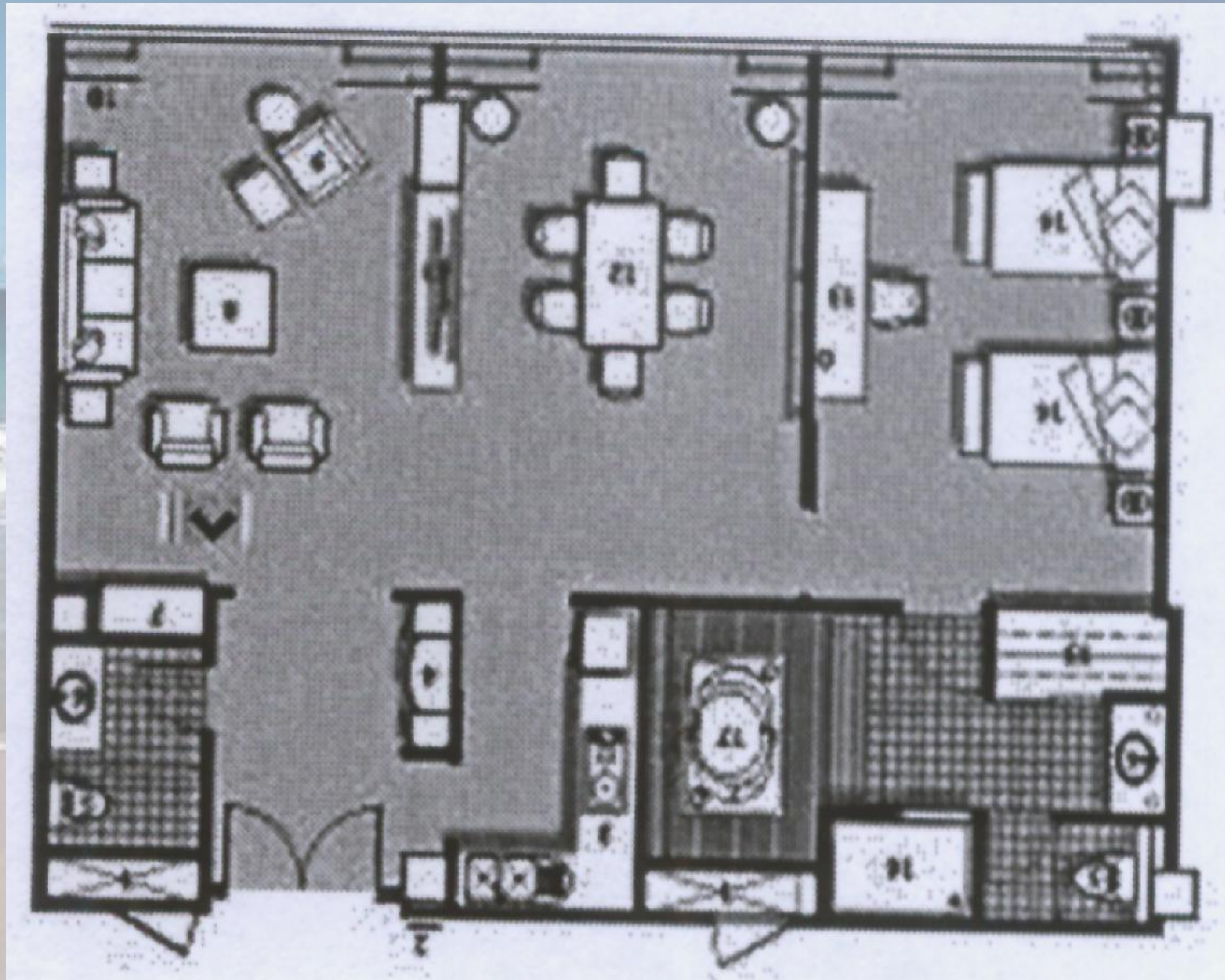

Example of suites standard dimensions

<u>Items</u>	<u>L</u>	<u>W</u>
Room	9.5m	8.5m
Bathroom	4.25m	3.10m
Bed	1.90m	1.20m

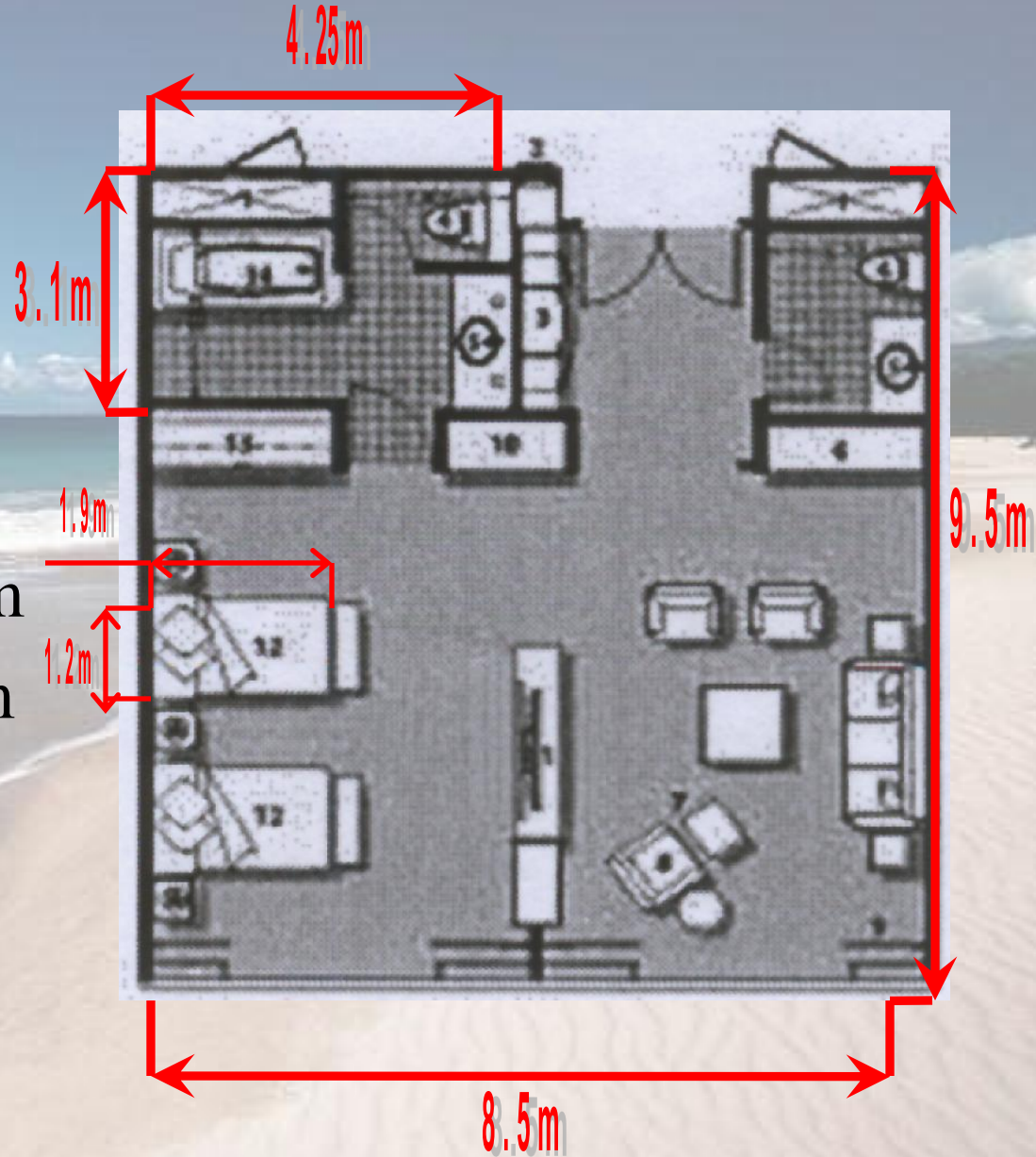

c. Dimensions of bathrooms

<u>Items</u>	<u>L</u>	<u>W</u>
Bathroom 1	1.80 m	1.40 m
Bathroom 2	2.11 m	1.22 m
Bathroom 3	1.61 m	0.86 m

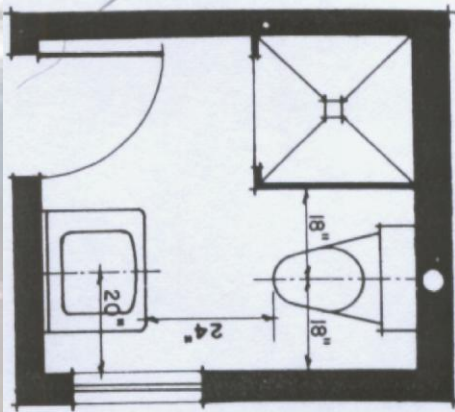

Bathroom 1

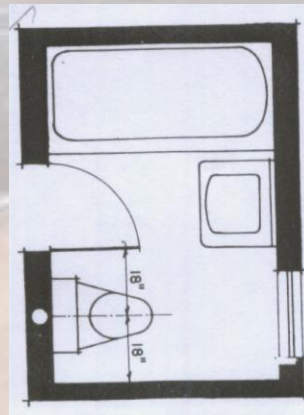

Bathroom 2

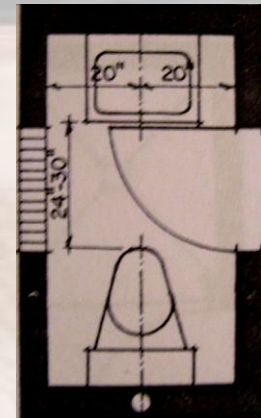

Bathroom 3



Fitness room

Shapes & Dimensions

Plan example

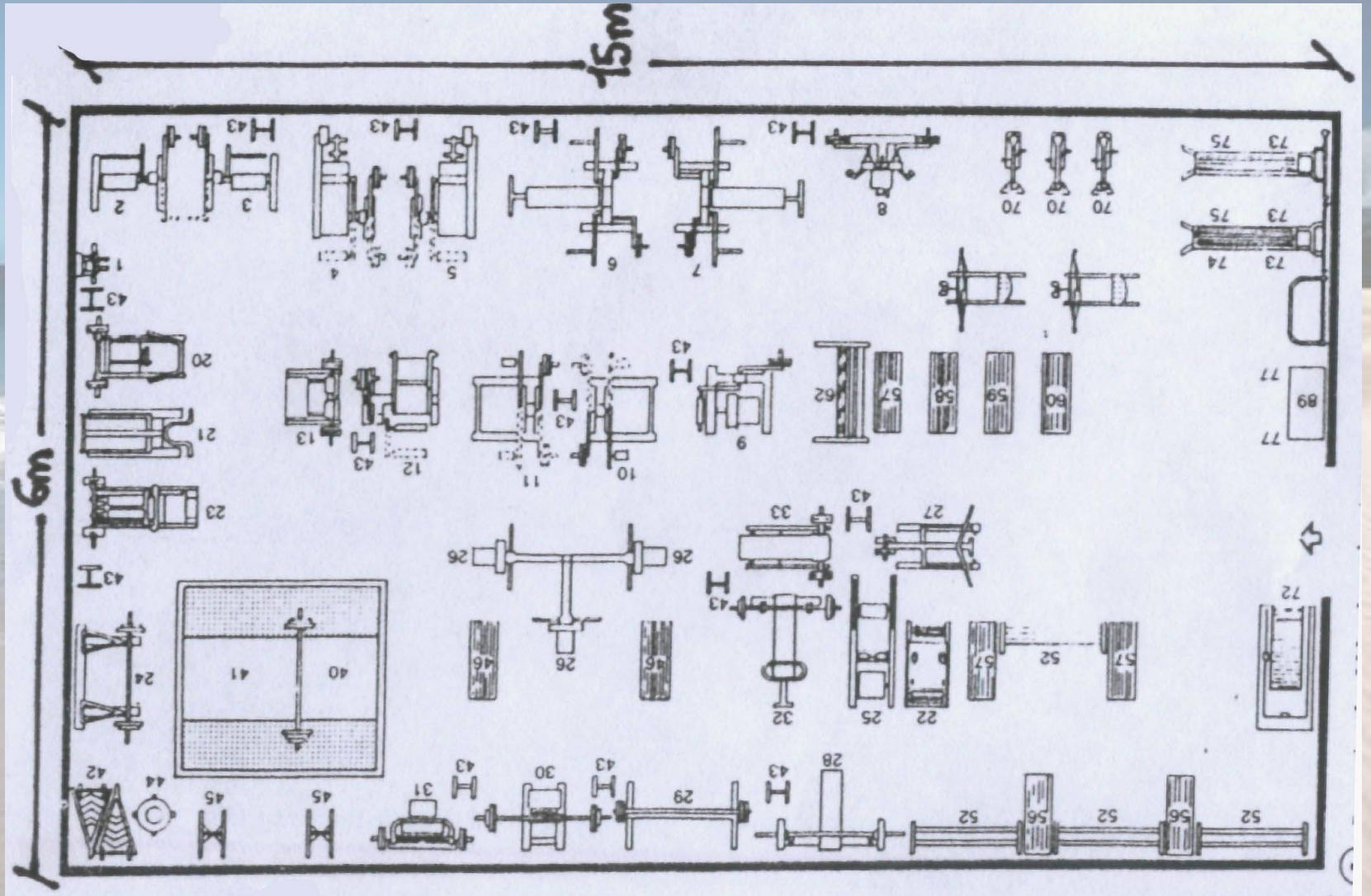

First Floor Plan for the Armory

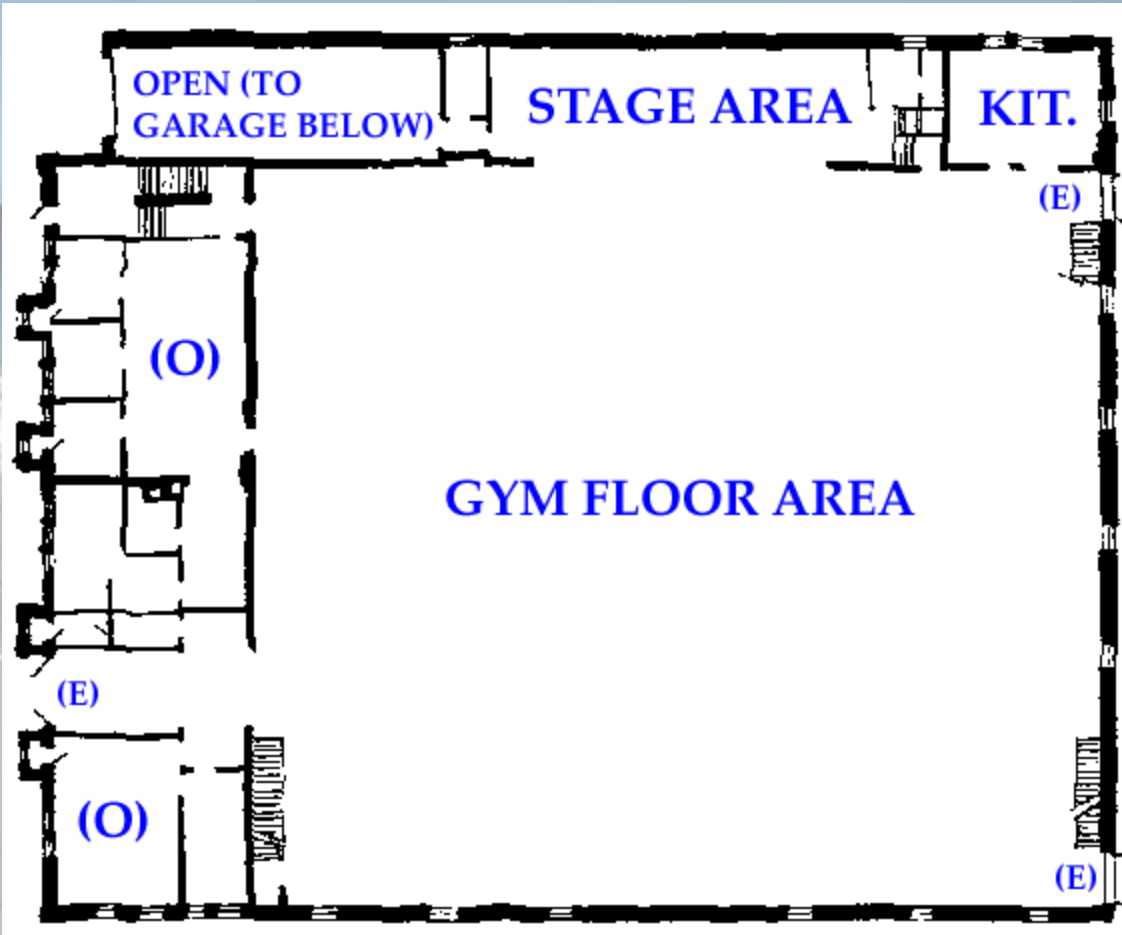

Major Dimensions:

Gym Floor - 96 feet x 126 feet
// Main Offices - 96 feet x 26 feet

Kitchen - 16 feet x 20 feet //
Balconey Width - 16 feet

Symbol Key:

(O) - Offices // KIT. - Kitchen
(E) - Exits //

Some equipment dimensions

weight: 33 Kg.



weight: 29 Kg.



Fitness room example





Jakozy

Shapes & Dimensions

Dimensions of Jakozy

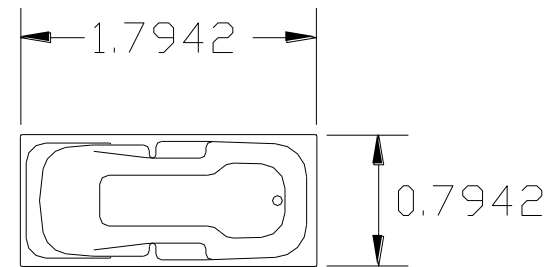
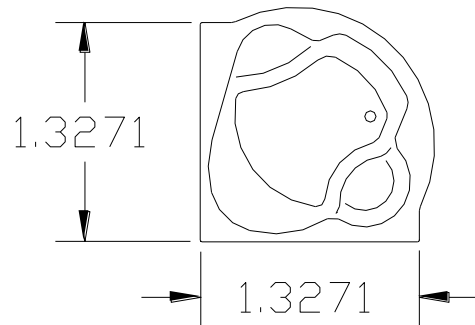
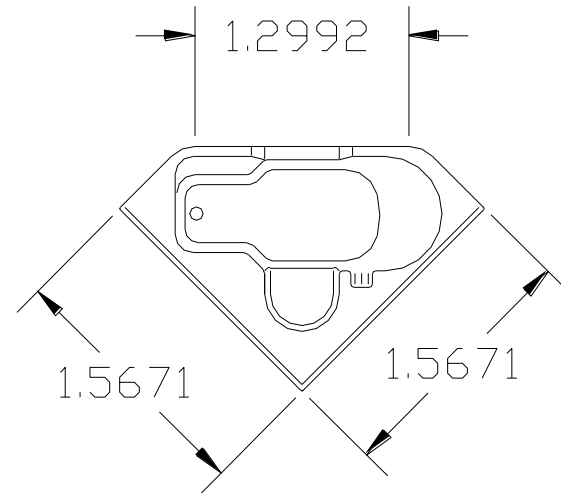
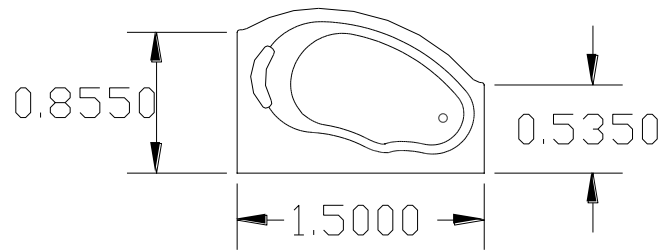

Examples of Jakozy







Sauna

Shapes & Dimensions

Dimensions of sauna area & the best clearance spaces

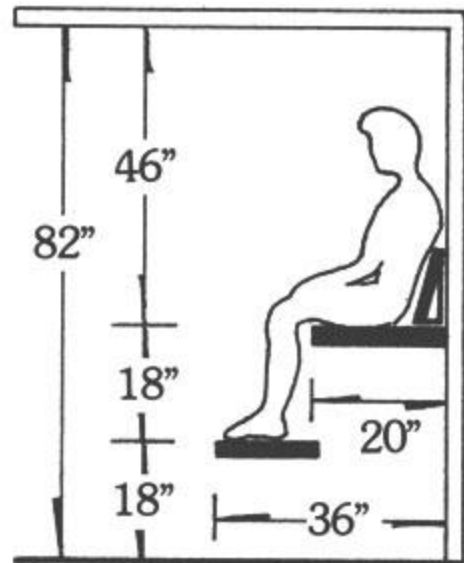

SITTING WITH BACK REST

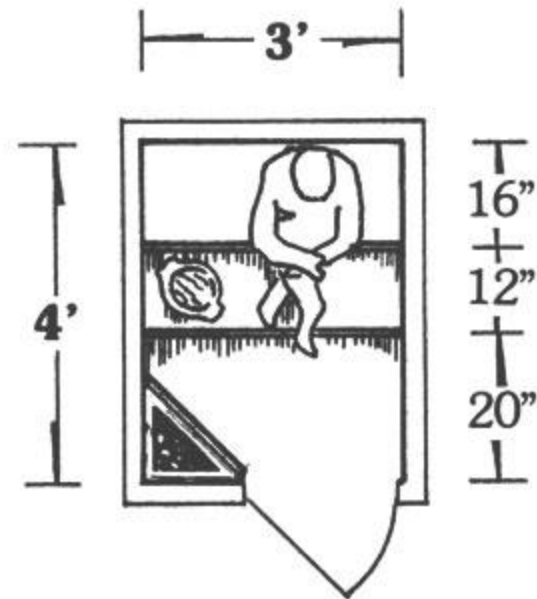

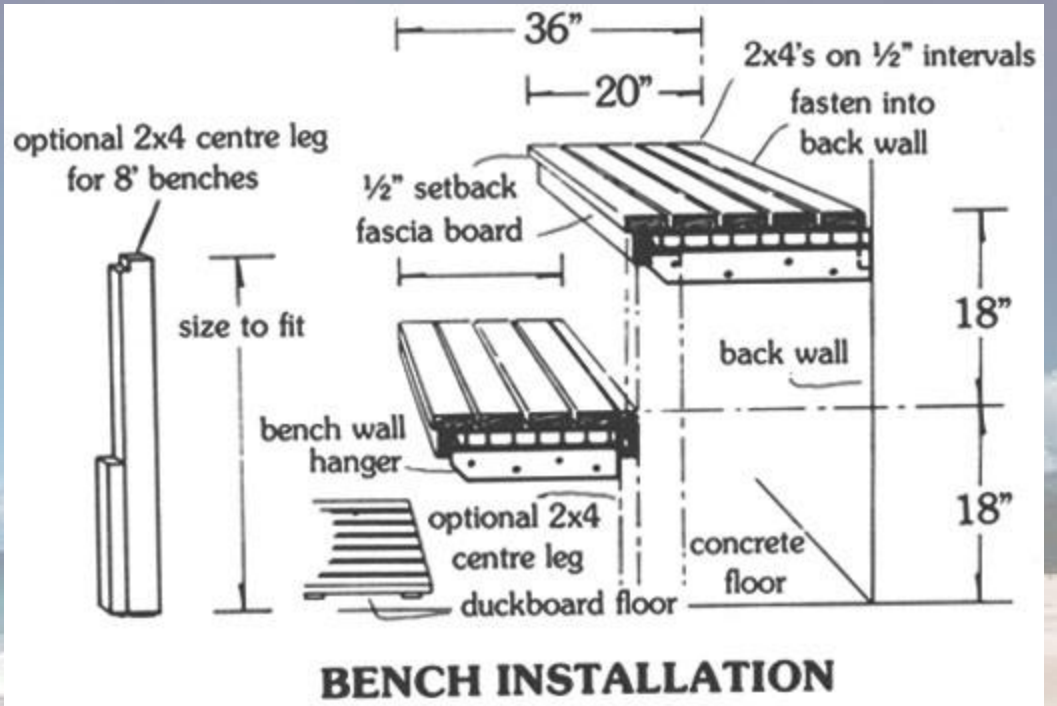
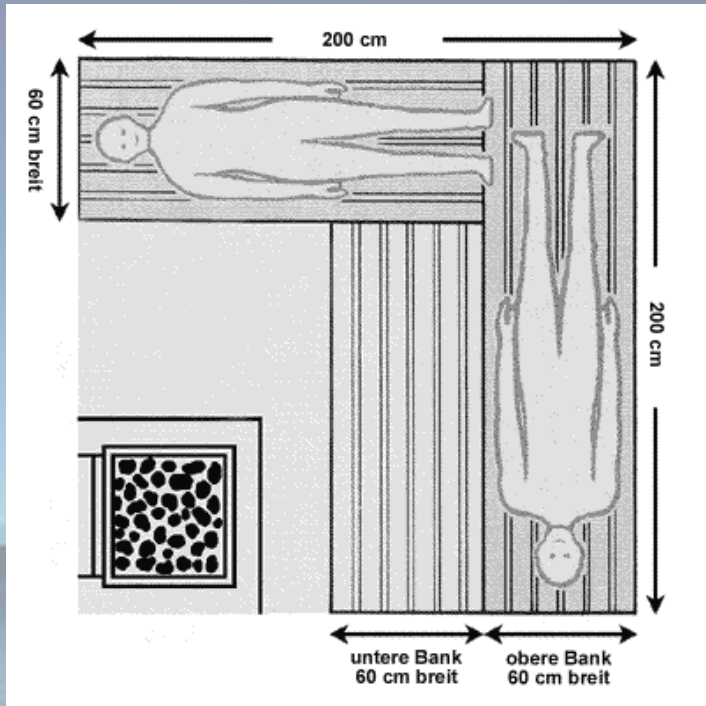

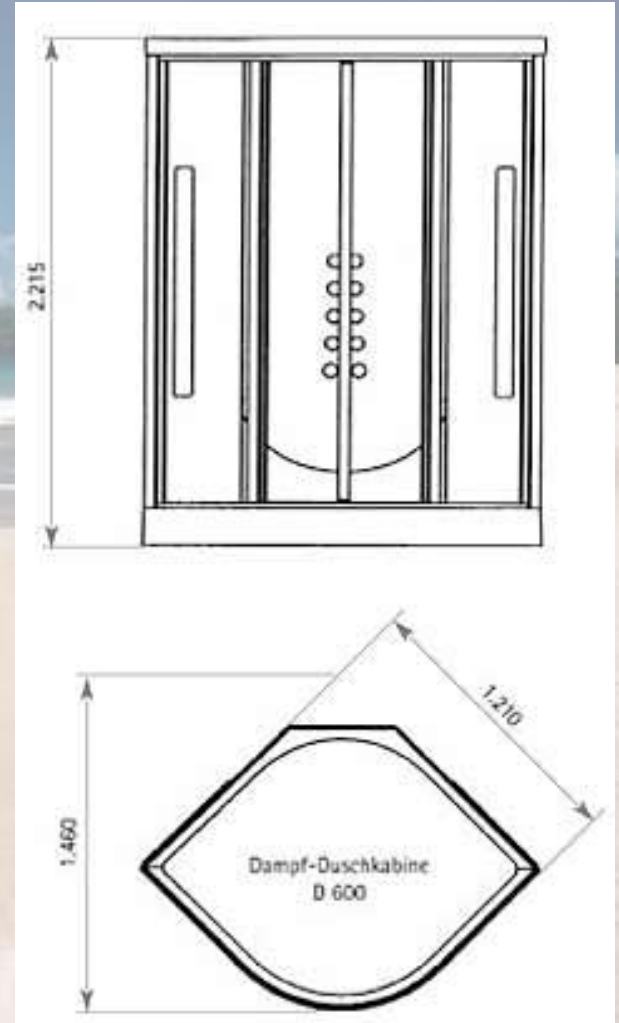
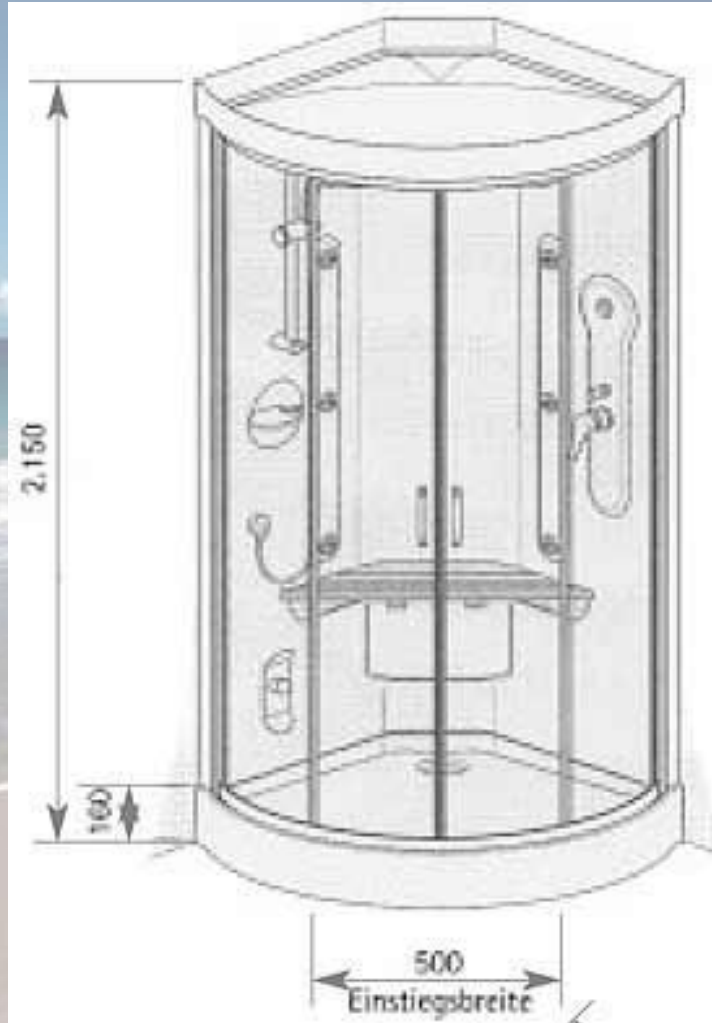



Clinic

Shapes & Dimensions

Shapes & Dimensions

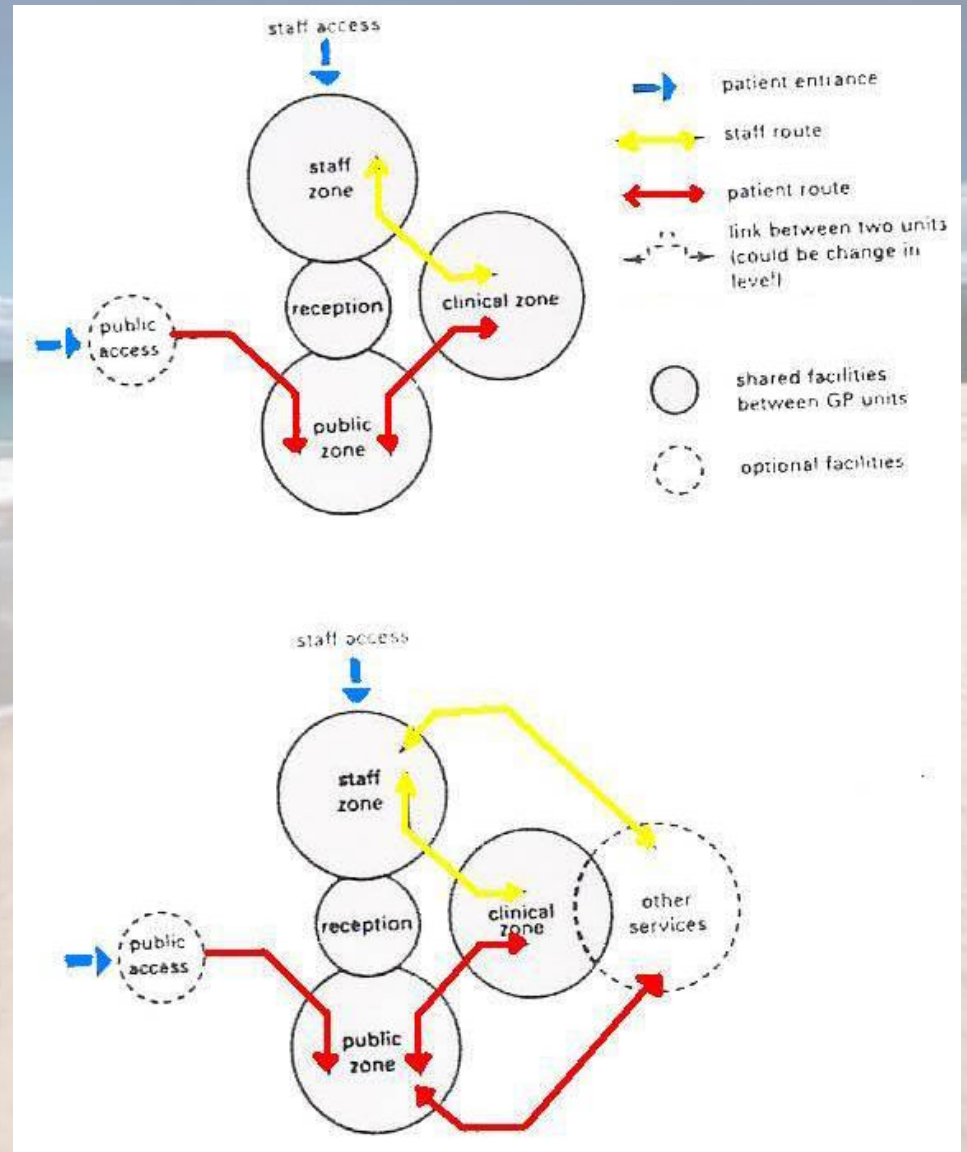
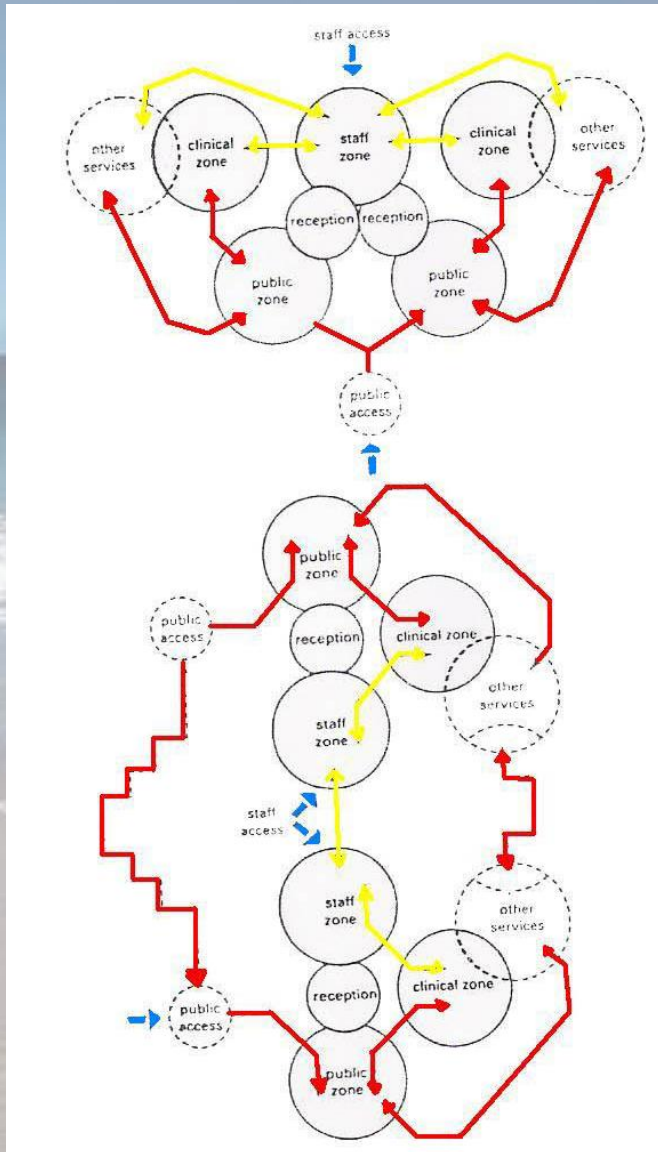

مكونات العيادات و مساحتها

Waiting room	$10*12 = 120$ square feet
Receptionist – combination nurse book keeper.....etc	$6*10=60$
Doctor's consultation office	$10*10=100$
Examining room	$8*10=80$
General storage	$3*5=15$
Corridor ,etc.....	100





Swimming pools

Shapes & Dimensions



Areas of Swimming pools & their capacity by persons

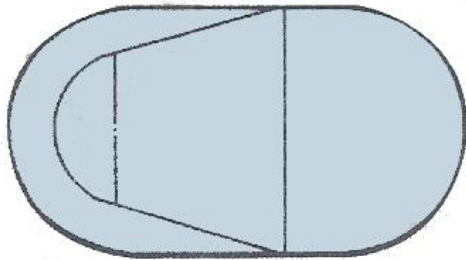

SQ.F.	PER.
504	86
572	94
640	102
858	110
378	76
165	48
283	64
393	76

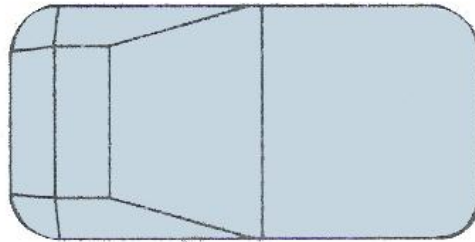

SQ.F.	PER.
524	92
588	100
627	100
690	108
780	110
860	118
1131	136
416	83.9

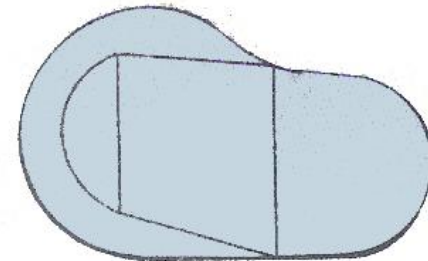

SQ.F.	PER.
485	86
583	94
643	102
810	110
381	76

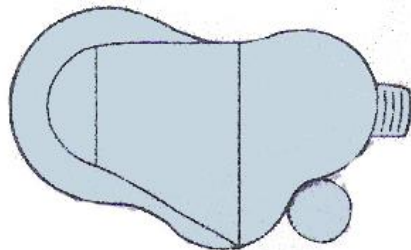

SQ.F.	PER.
351	76
571	94
778	110

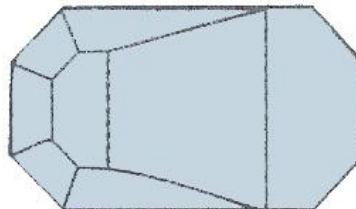

SQ.F.	PER.
607	96
490	88

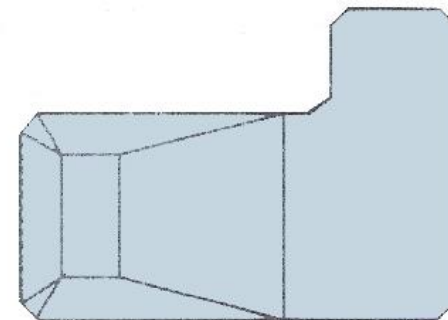

SQ.F.	PER.
688	118
960	138
472	94

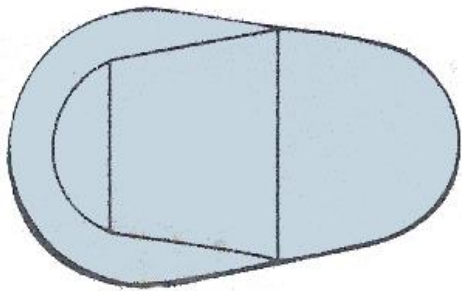

SQ.F.	PER.
616	94
840	110
400	76

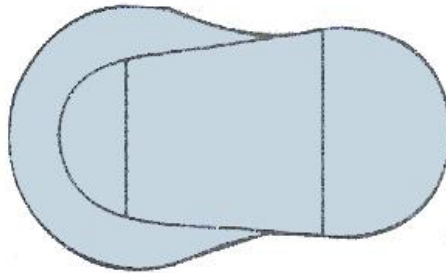

SQ.F.	PER.
583	94
382	76

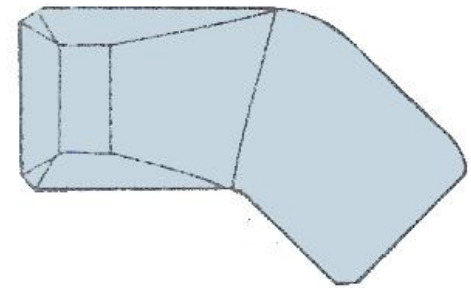

SQ.F.	PER.
648	109
774	121
964	132

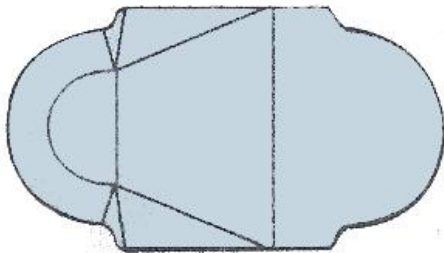

SQ.F.	PER.
544	91
864	115

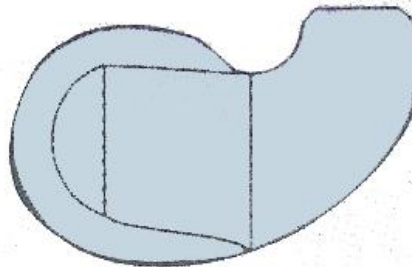

SQ.F.	PER.
625	104
871	122

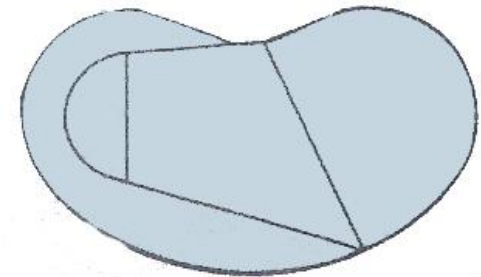

SQ.F.	PER.
605	94
803	110



SQ.F.	PER.
320	92

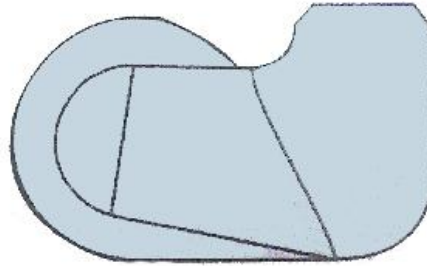

SQ.F.	PER.
733	112

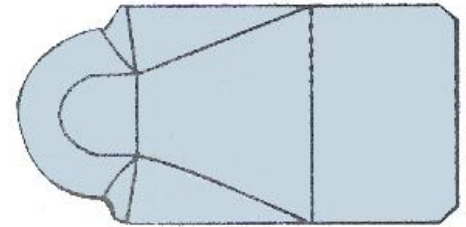

SQ.F.	PER.
650	102
730	110

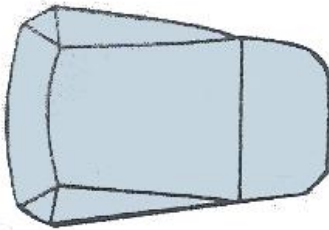

SQ.F.	PER.
458	84

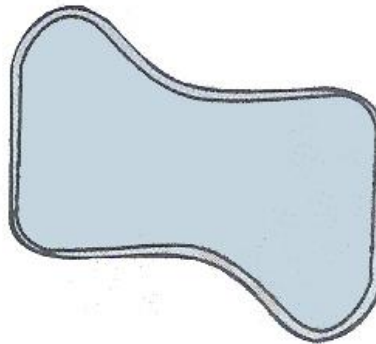

SQ.F.	PER.
674'	110'

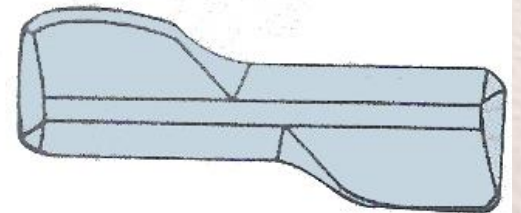

SQ.F.	PER.
430'	102'



Parking

Shapes & Dimensions

a. Kinds of vehicles.

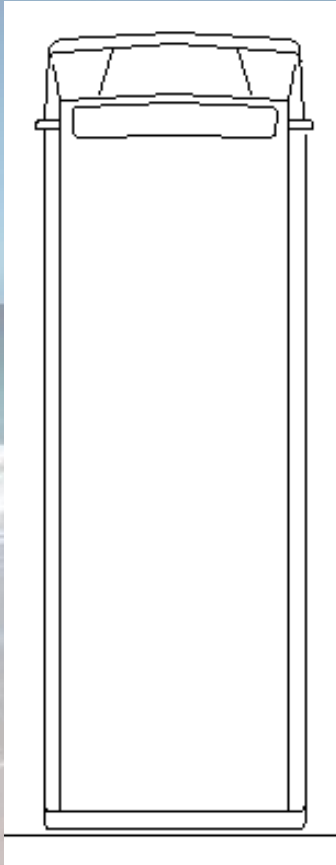

Bus

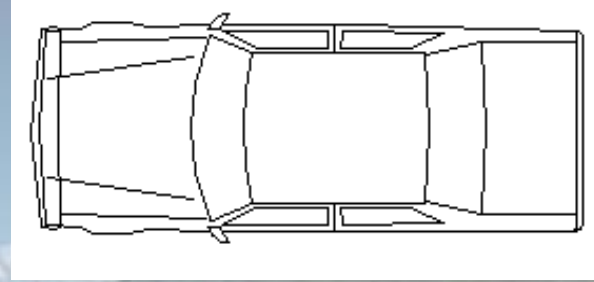

Car

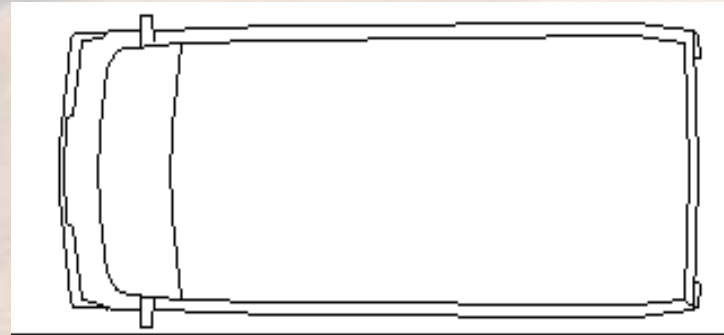

Lorry

c. Dimensions of Vehicles

Items

L

W

Car

4.7 m

1.77 m

Lorry

8.35 m

2.48 m

Bus

12 m

4 m

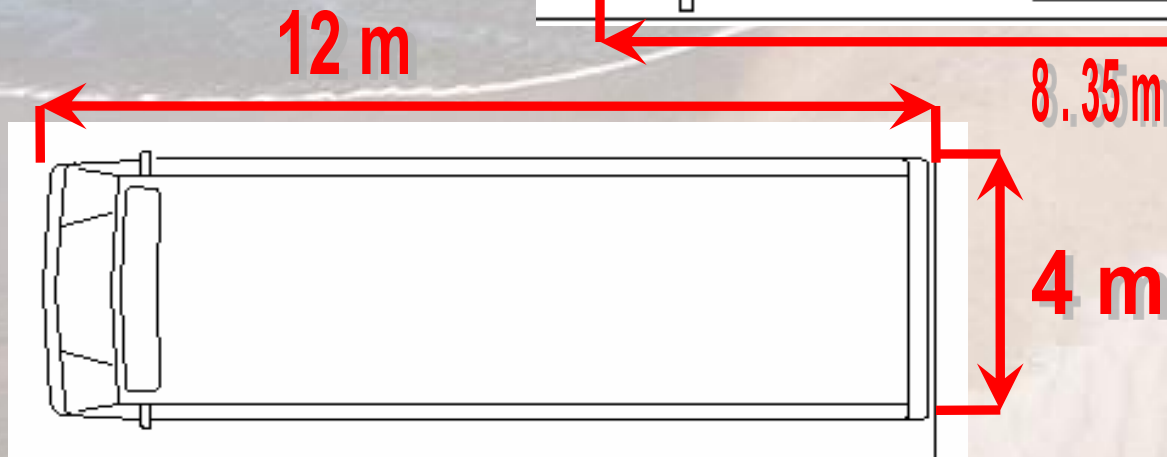
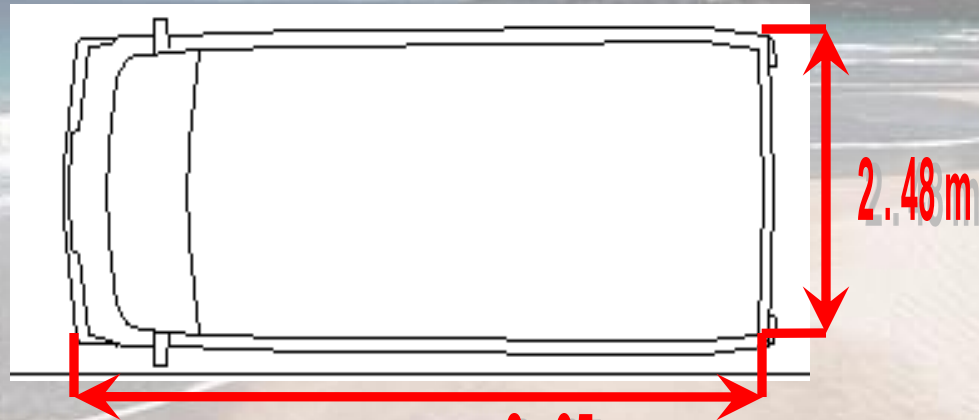
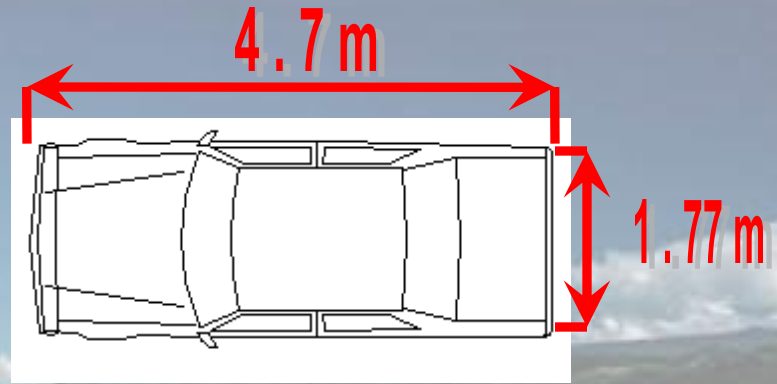

d. Car lots examples

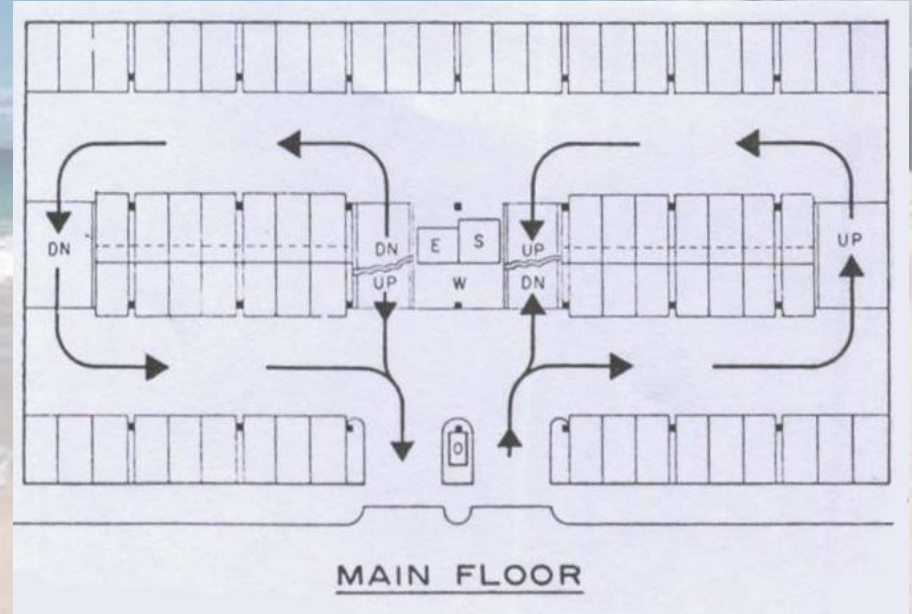
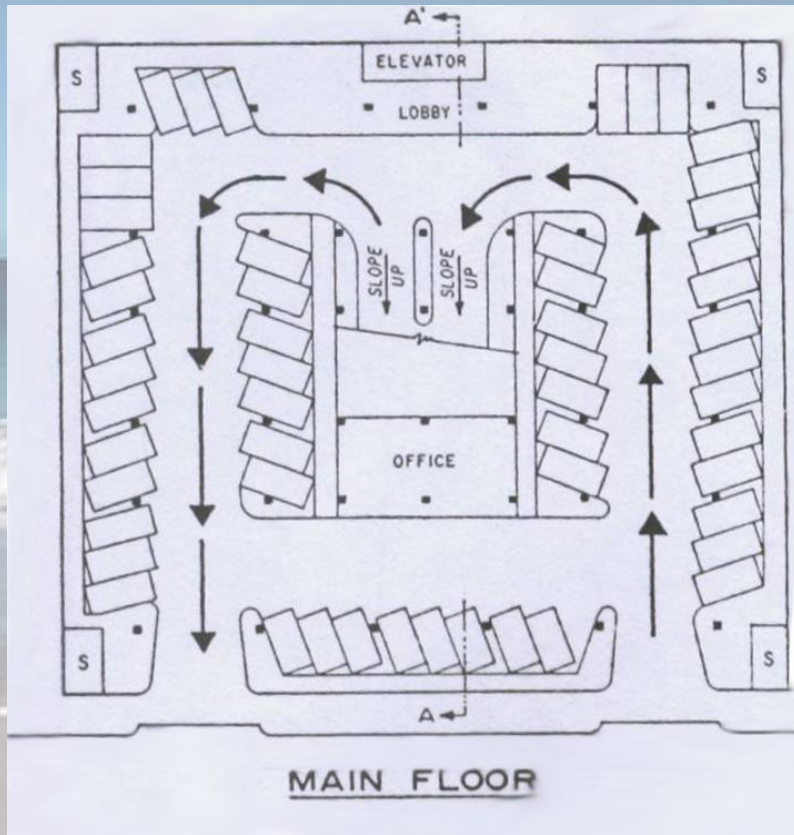

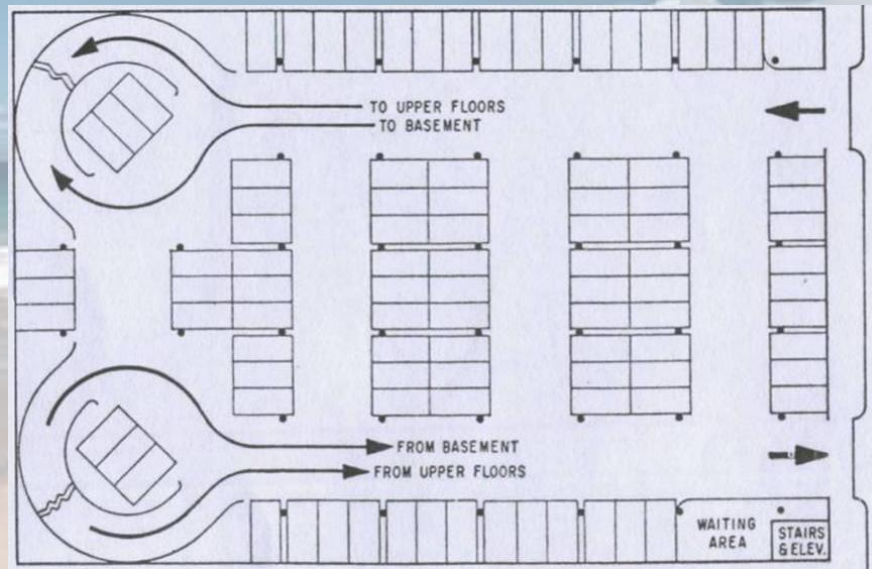
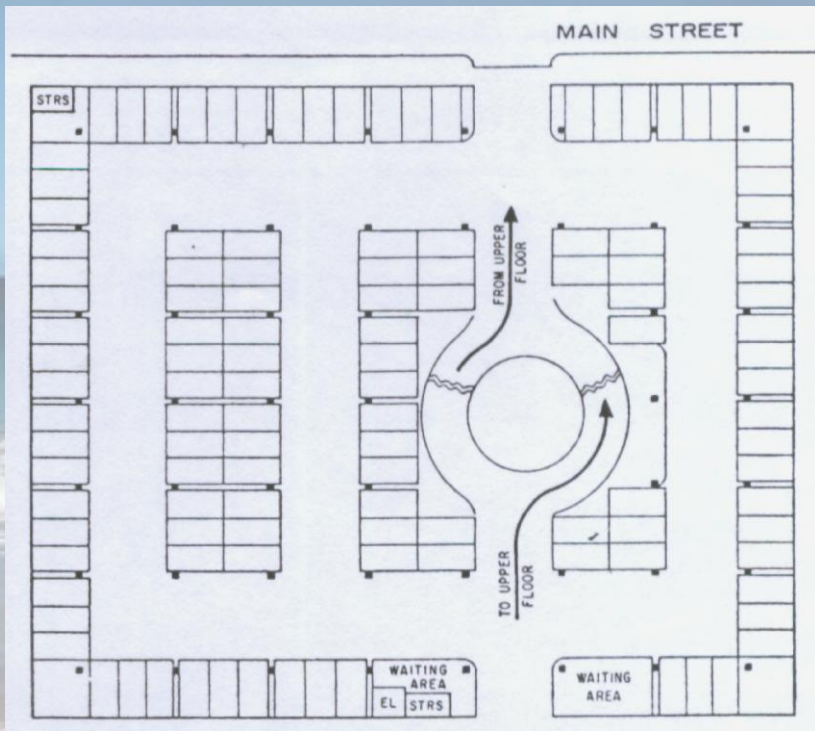

An aerial photograph of a wide, sandy beach. The ocean waves are breaking on the left side, creating white foam. The sand is light-colored and shows some ripples. The sky is blue with scattered white clouds. The text "Structure system" is overlaid in the center in a bold, italicized black font.

Structure system

Hollow Blocks System

HOLLOW BLOCKS SLAB SYSTEM

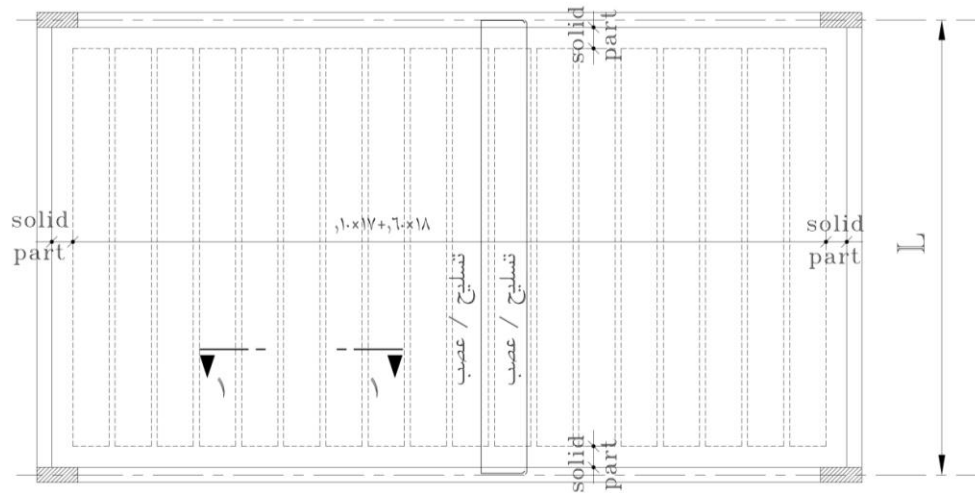

one way hollow blocks

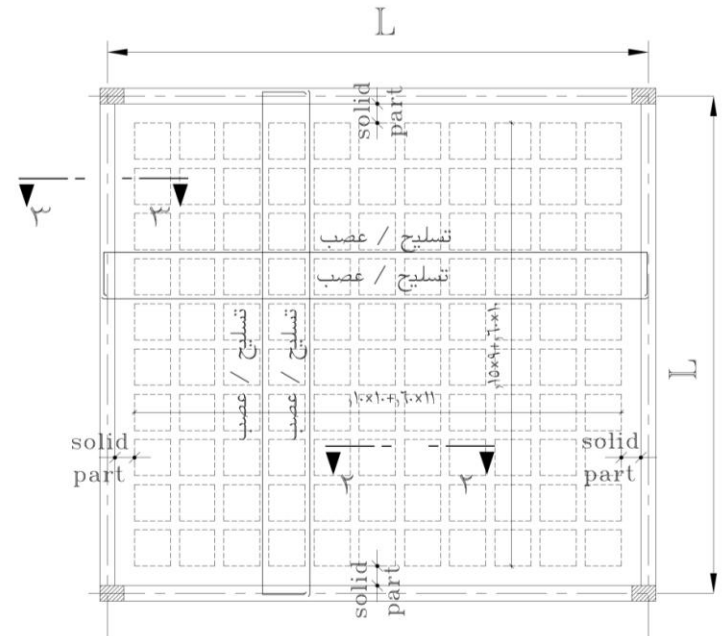

two way hollow blocks

H.B Slab Sections

HOLLOW BLOCKS SLAB SECTIONS

شبكة ٨/٥٠ م فى الاتجاهين

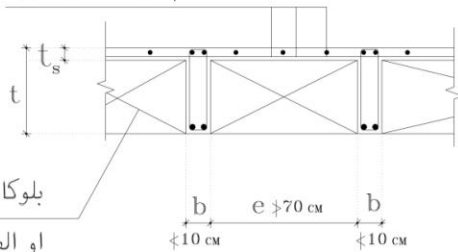

بلوكات من الفوم
او الطوب المفرغ

قطاع (١-١)

شبكة ٨/٥٠ م فى الاتجاهين

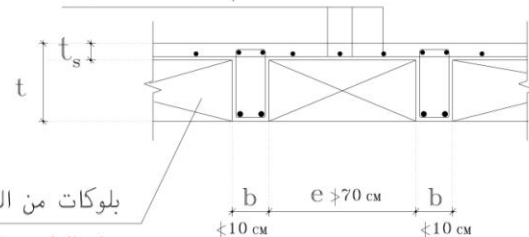

بلوكات من الفوم
او الطوب المفرغ

قطاع (٢-٢)

شبكة ٨/٥٠ م فى الاتجاهين

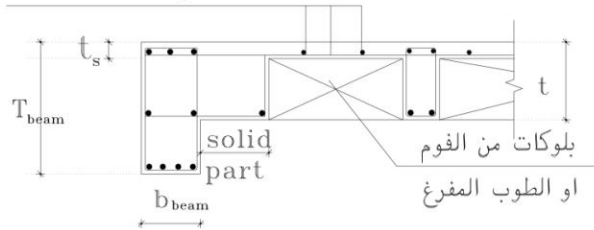

بلوكات من الفوم
او الطوب المفرغ

قطاع (٣-٣)

$t_s = \text{THE BIGGER OF } \begin{cases} 5 \text{ CM} \\ e/10 \end{cases}$

SOLID PART $\leq 15 \text{ CM}$

$$t = \frac{L}{16}$$

Flat Slab System

FLAT SLAB SYSTEM

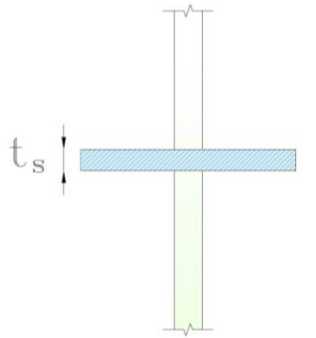

ORDINARY FLAT SLAB

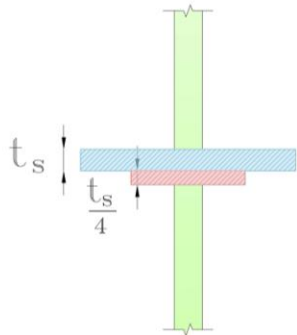

FLAT SLAB WITH DROP PANEL

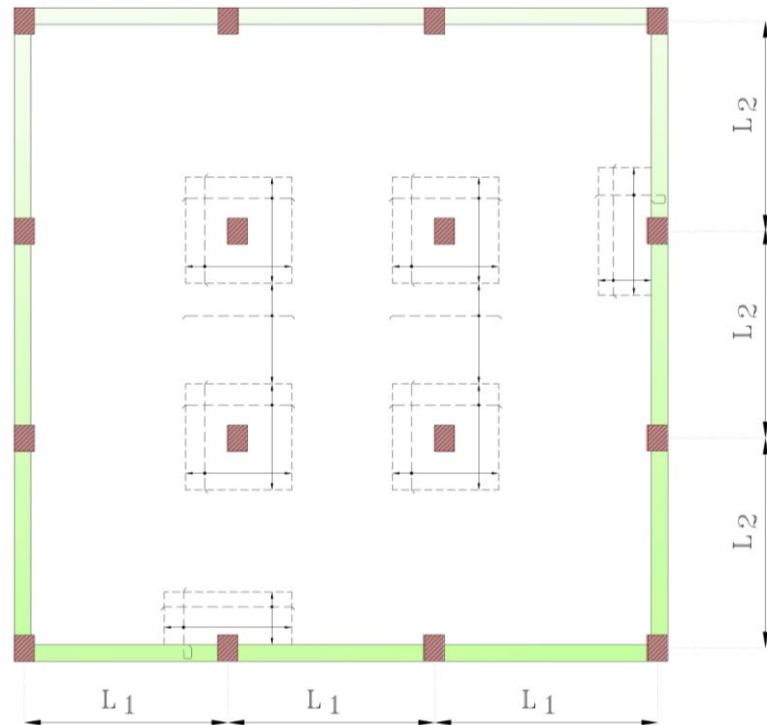

$$t_s > 15 \text{ cm}, \quad t_s = \frac{L}{32}, \quad L = \frac{L_1 + L_2}{2}$$

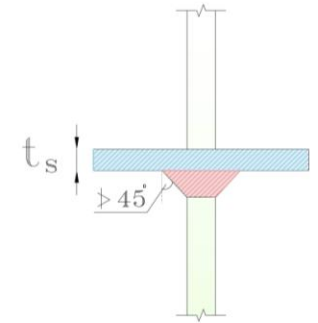

FLAT SLAB WITH COLUMN HEAD

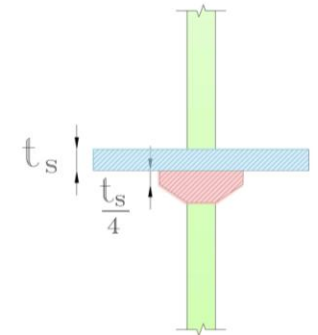

FLAT SLAB WITH COLUMN HEAD
& DROP PANEL



Panelled Beam Slab System

PANELLED BEAM SLAB SYSTEM

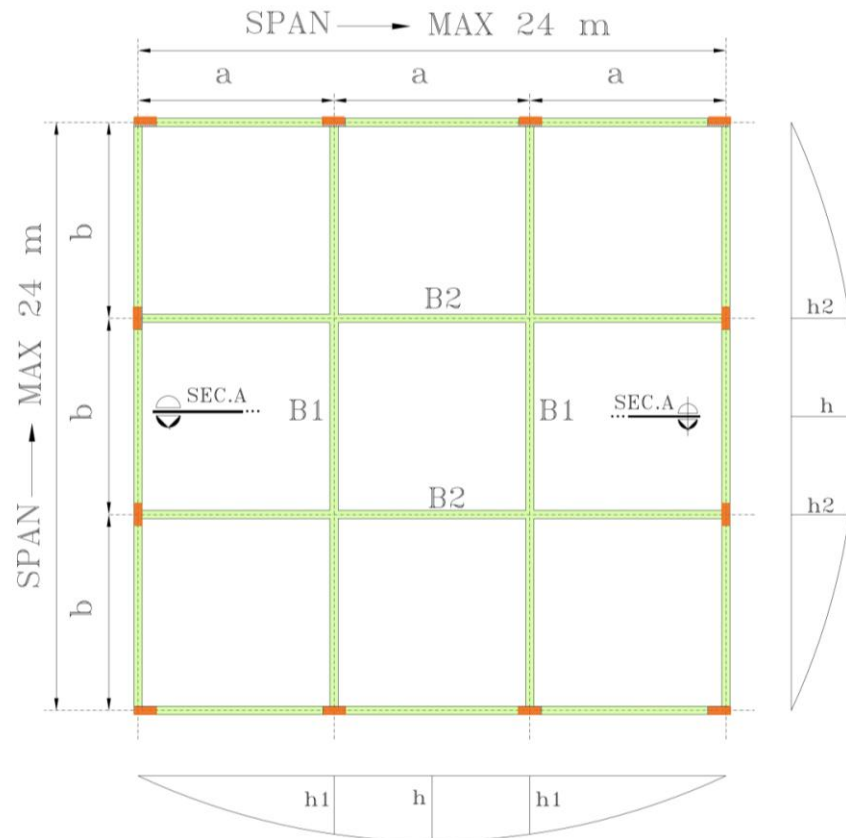

$$t = \text{SHORT SPAN} / 14 \leftrightarrow 18$$

$$a, b \rightarrow (2 \rightarrow 5) \text{ m}$$

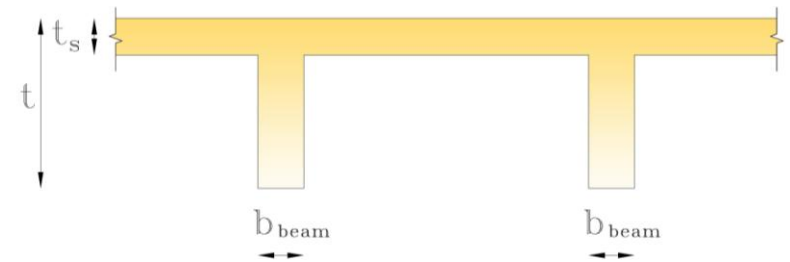

SEC A-A



R.C Halls

R.C HALLS



ARCH



L 20 → 40 m

ARCH WITH A TIE

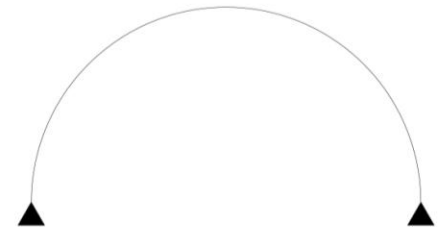

HALF CIRCLE

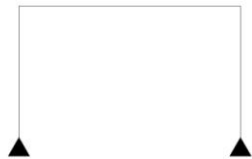

FRAMES



L 20 → 40 m

VERANDEEL

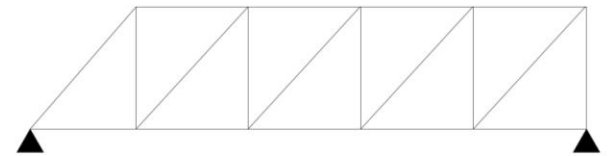

L 20 → 40 m

TRUSS

Frame

FRAME

$$t_g = \frac{L}{14} \leftrightarrow \frac{L}{18}$$

$$t_c = (0.9) t_g$$

$$t_b = 0.6 t_c$$

$$X = 2 \leftrightarrow 5 \text{ m}$$

$$\text{spacing} = 2 \leftrightarrow 5 \text{ m}$$

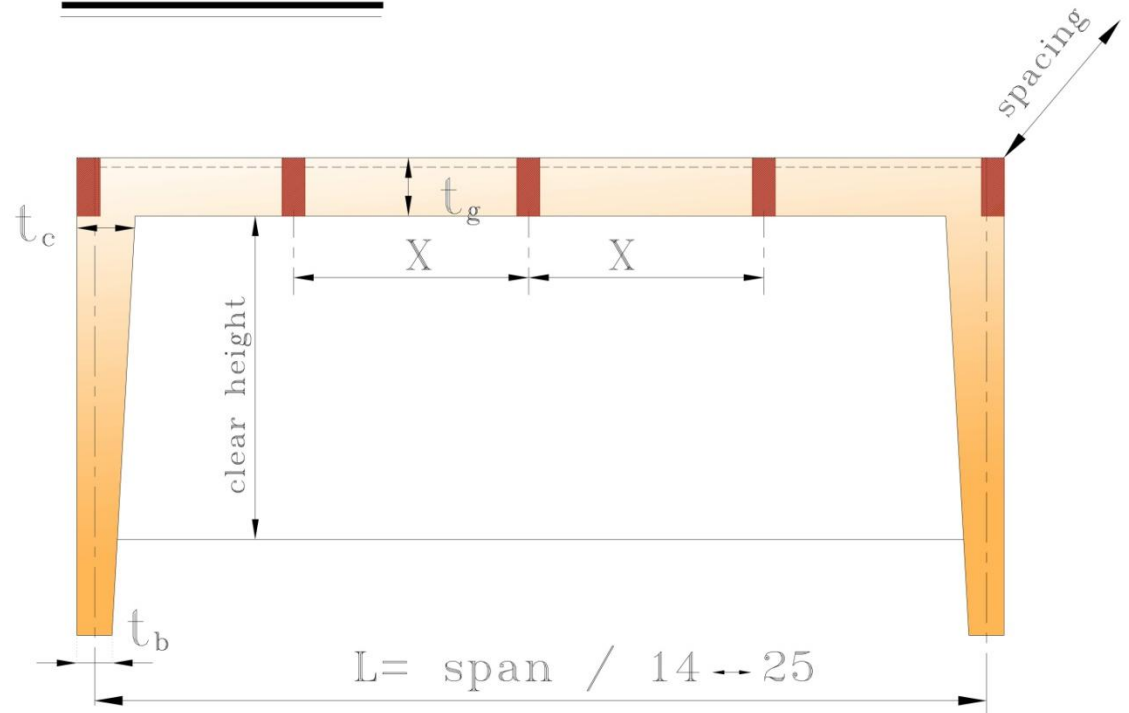

Frame Straining Actions

FRAME STRAINING ACTIONS

MOMENT DIAGRAM

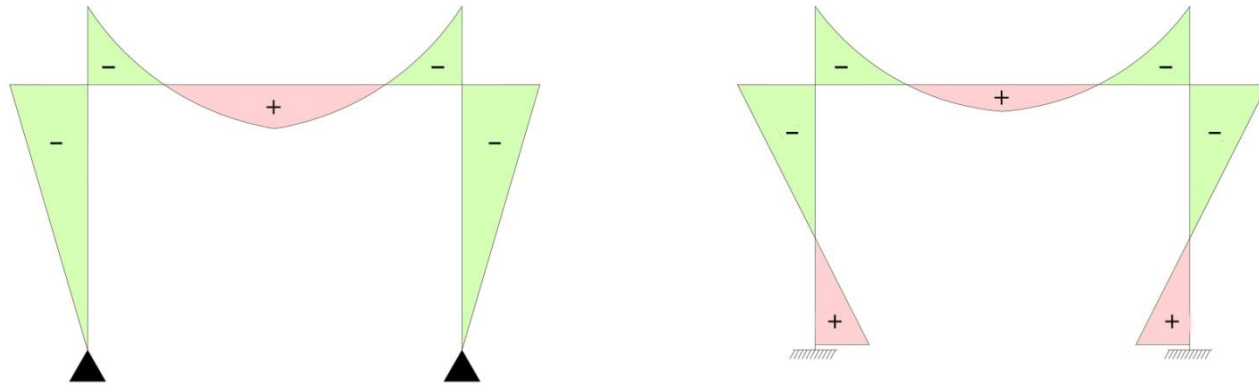

REACTION

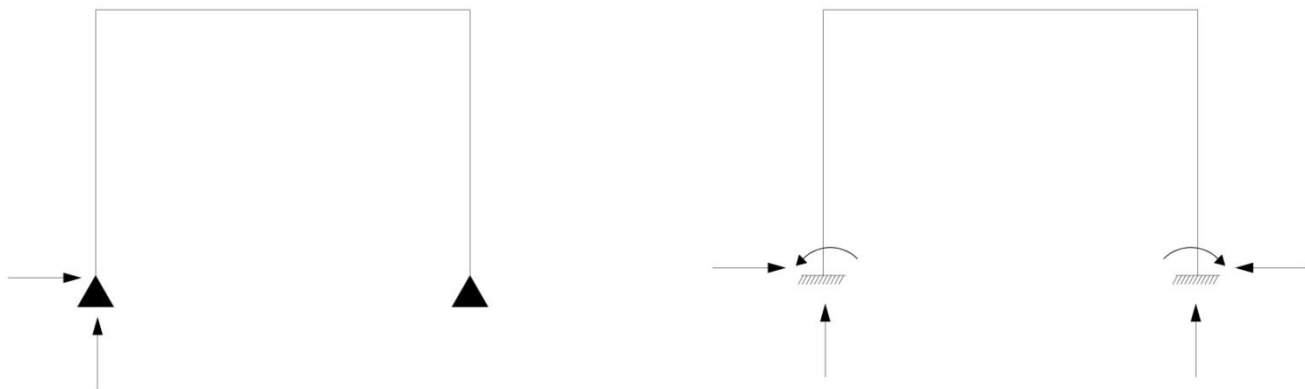

Arch With A Tie

ARCH WITH A TIE

$$L = 25 \rightarrow 40 \text{ m}$$

$$\text{spacing} = 2f$$

$$f = \frac{L}{6} \rightarrow \frac{L}{8}$$

$$t_g = \frac{L}{25} \rightarrow \frac{L}{30}$$

$$y_i = 4f \frac{X_i(L-X_i)}{L^2}$$

$$t_{\text{tie}} = t_g / 2$$

$$b = 30 \rightarrow 40 \text{ cm}$$

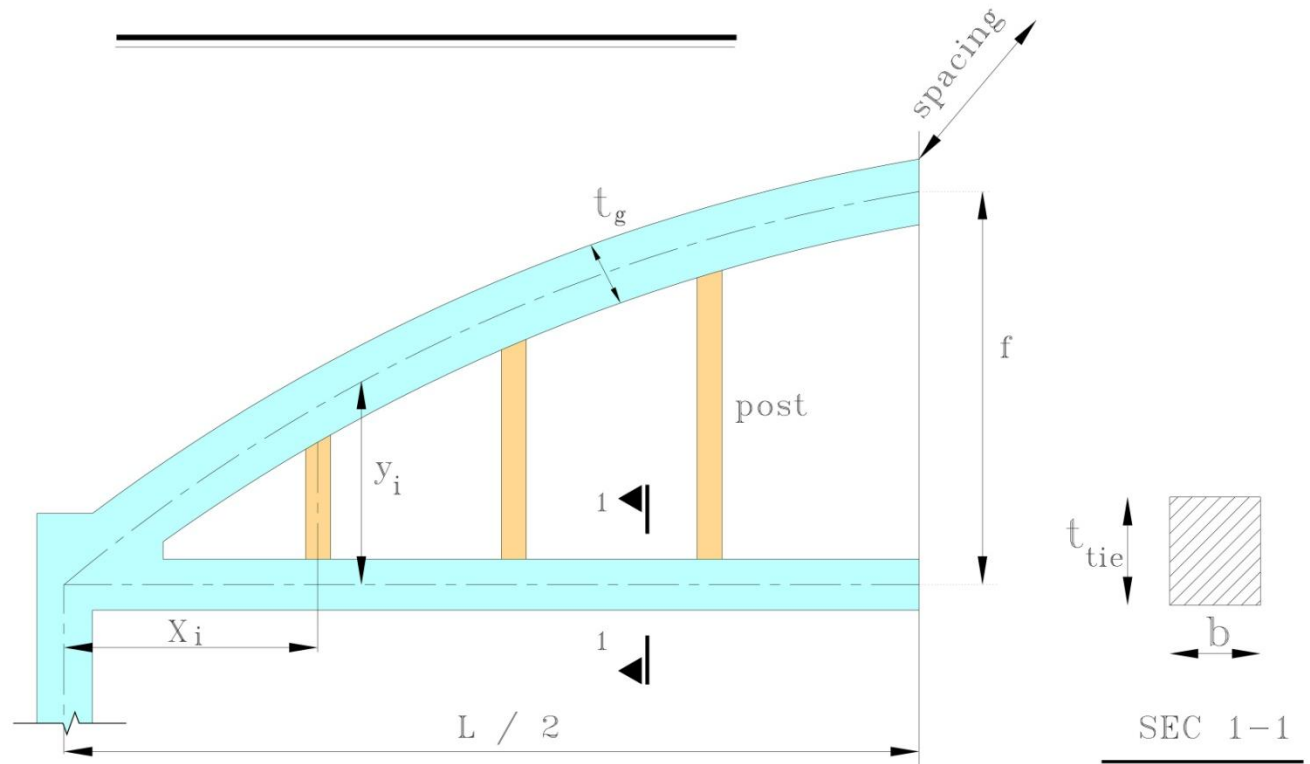

Arch Straining Actions

ARCH STRAINING ACTIONS

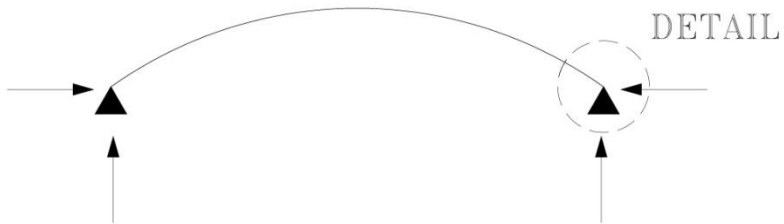

ARCH

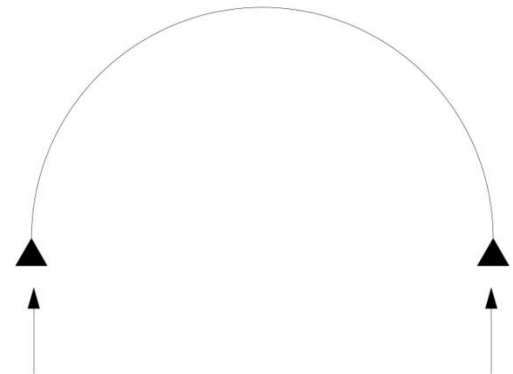

HALF CIRCLE



DETAIL 1



DETAIL 2

